

Sprinkler piping system

aquatherm red



4	History __		
5	About aquatherm __		
6	Application fields __		
	Product types __		
10	General product information		
13	Diameter and pressure stages		
	Characteristics and special features __		
16	International approvals		
17	Approvals		
18	Handling		
20	Fire protection		
22	Material fusiolen®		
24	Sustainability		
26	Environmental Product Declaration LEED-Certification		
	Fusion __		
32	Processing possibilities		
35	Part A: Mounting of the welding tools		
38	Part B: Preparation of the fusion		
42	Part C: Weld-in saddles		
44	Part D: Welding jig		
47	Part E: Welding machines		
49	Part F: Repair		
51	Article list __		
73	Laying in the concrete __		
	Testing __		
86	Leakage test and chemical resistance		
	Fields of Application __		
90	Fire protection and sprinkler systems		
93	Quality assurance __		
94	„100 % Made in Germany“		
95	Compliance with the system standard		
95	Certificate		
97	aquatherm Services __		
98	aquatherm Prefabrication		
101	References __		
102	Kö-Bogen I and II		
104	KTM Motohall		
106	UN Campus		
109	Warranty __		
113	Transport & storage __		

History __

- 1973 aquatherm founded by Gerhard Rosenberg
- 1981 development of the first pipe system made of polypropylene; the colour green becomes a characteristic feature of aquatherm
- 1991 subsidiary Radeberg was founded
- 1996 first certification of the quality management system in accordance with ISO 9001
- 1997 foundation of the sales company in Italy
- 1999 development of fusiotherm® fibre composite pipe
- 2001 aquatherm operates in more than 50 export markets
- 2002 market launch of the aquatherm blue pipe
- 2005 market launch of the aquatherm red pipe and aquatherm black system
- 2010 system expansion of the pipe size to max. ø 630 mm
- 2010 Christof, Dirk and Maik Rosenberg assume company management
- 2012 first certification of the environment management system in accordance with ISO 14001
- 2012 market launch of the material fusiolen® PP-RP
- 2013 first certification of the energy management system in accordance with ISO 50001
- 2017 opening of the new pipe extrusion plant
- 2018 opening of the new injection moulding facility
- 2018 foundation of the sales company in England
- 2019 expansion of the industrial prefabrication operation
- 2021 participation in the distribution company aquatherm iberica s.l.
- 2022 opening of the aquatherm Campus
- 2023 aquatherm celebrates it's 50th anniversary
- 2024 Jan Kriedel takes over the management with Maik Rosenberg

AQUATHERM RED

Plastic piping systems made of polypropylene __

aquatherm is the world's leading manufacturer of plastic piping systems made from polypropylene for plant construction and building services. The areas of application include drinking water applications, heating systems, fire protection sprinkler systems, air-conditioning and refrigeration technology, as well as surface cooling systems. The product range comprises more than 17,000 articles in six product lines.

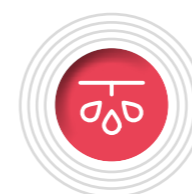
To guarantee the worldwide availability of the products and to offer local service, aquatherm works closely with long-standing partners in more than 70 countries. The company employs approx. 500 people in Germany, Italy and England. Pro-

duction is carried out exclusively at the German sites in Attendorn (headquarters) and Ennest. Customers all over the world can therefore rely on innovative and safe PP-R piping systems of the highest quality, „100% Made in Germany“. The family business is now managed by Maik Rosenberg, son of aquatherm founder Gerhard Rosenberg, and Jan Kriedel.

AQUATHERM RED

**Future-proof in all fields of application
with individual solutions __**

aquatherm has the solution for your challenge - benefit from the versatile application possibilities of aquatherm red systems. Here you get an exemplary overview of the fields of application where you can trust in aquatherm red. Yesterday. Today. Tomorrow.



fire protection



sprinkler systems



aquatherm red
Product types

AQUATHERM PRODUCT TYPES

Polypropylene pipe systems __

The history of the aquatherm pipe systems began in 1973 when Gerhard Rosenberg founded a company for hot water underfloor heating systems. Initially, the owner's garage and basement served as the company's headquarters and production facility. A lot has happened since then.

In the past 50 years, aquatherm has proven to be the world's leading manufacturer of plastic pipe systems made of polypropylene for plant engineering and building services. The numerous product lines provide superior solutions in potable water applications,

heating systems, fire sprinkler systems, air conditioning and refrigeration technology, as well as in surface heating and cooling systems. The product range comprises almost 17,000 articles in six product lines.

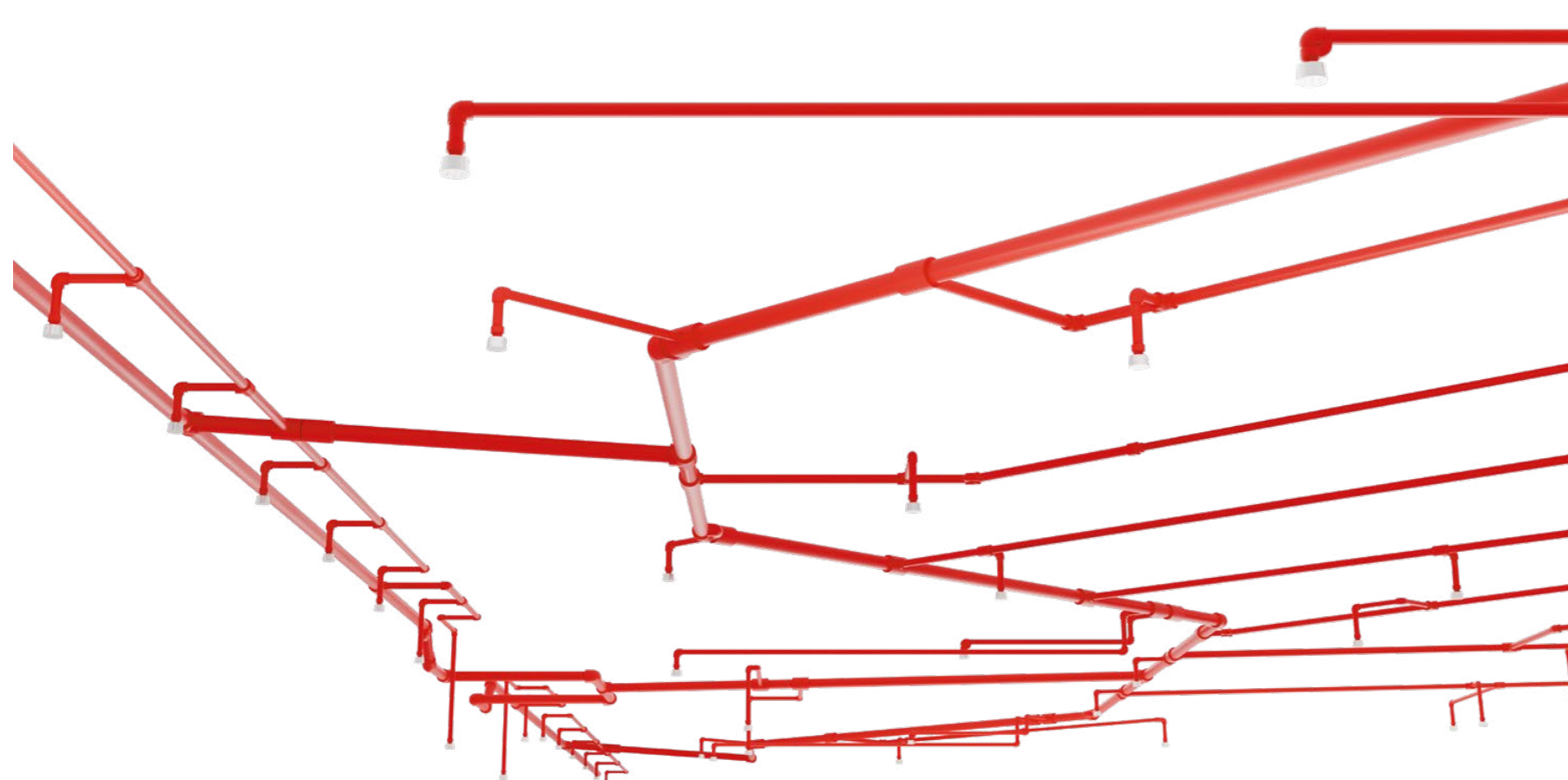
Due to their special material properties, the aquatherm pipe systems convince by their diverse application possibilities.

The aquatherm pipe systems can be used in all areas of new installation, repair and renovation.

Installation __

aquatherm offers unrivalled connection technology: Material unity through fusion. It convinces with shortest connection times:
e.g. outer diameter 40 mm = 12 sec.

aquatherm connections can be pressurised or put into operation immediately after fusion. immediately after fusion. There are no waiting times.



Quality __

Quality is very important to aquatherm. This is not only reflected in the national and international certification marks, but also in the high satisfaction level of aquatherm customers, installers and engineers. You can find our international certificates here: [Certificates](#)

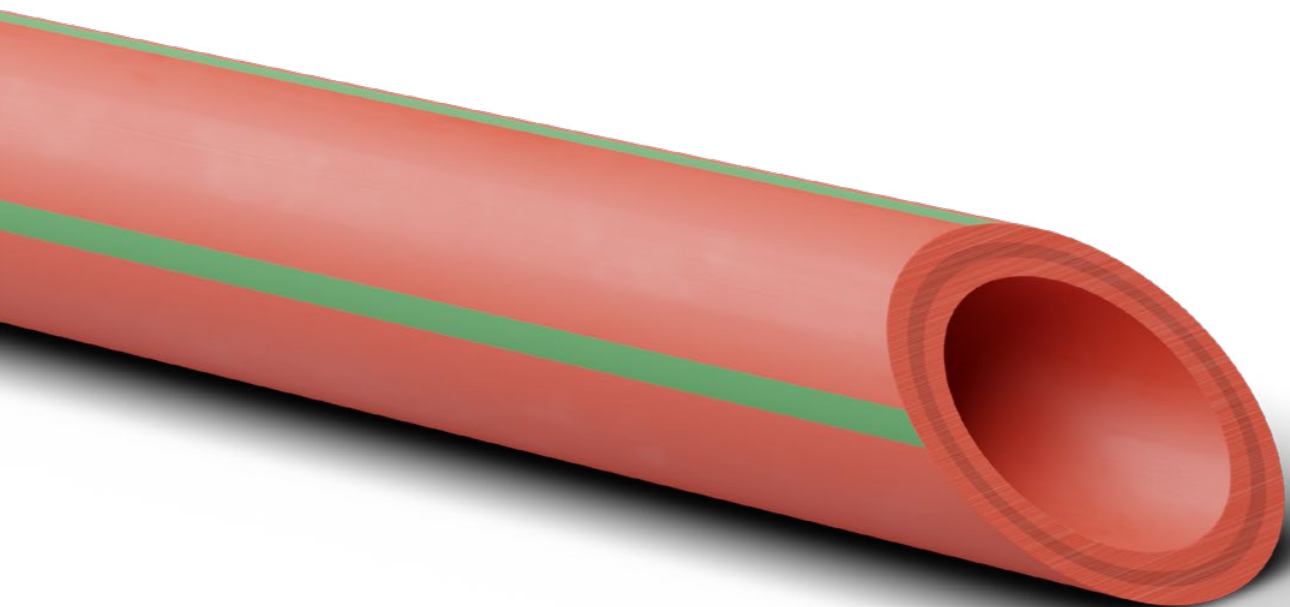
Warranty __

Due to the high product quality, aquatherm offers a 10-year warranty on all pipes and fittings instead of the 2 years applicable under German law. The extended warranty period is covered by a comprehensive insurance policy from a leading insurance company in our industry. For details, see the Warranty section of this catalogue.

Price advantage __

aquatherm offers you high quality, durable piping systems at an optimal price/performance ratio.












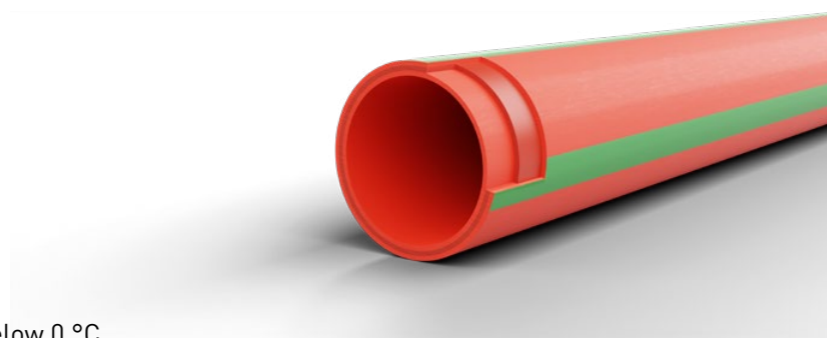
PRODUCT TYPES

AQUATHERM RED MF HI __



MF = multi-layer and fibre-reinforced composite pipe
 HI = highly inflammable

Advantages at a glance:

-  high corrosion resistance
-  short processing time
-  lighter than metallic materials
-  non-visible fire protection
-  sealing elements are not required
-  high impact strength
-  processing even at temperatures below 0 °C



Fields of application __

-  fire protection
-  sprinkler systems

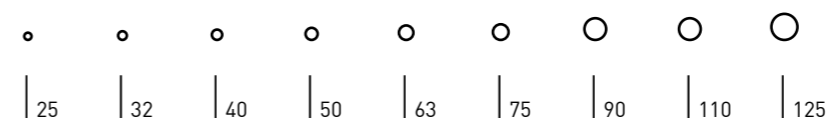
System components __

The system provides all components required for the piping installation of sprinkler systems.

- pipes in straight lengths
- fittings
- flanged joints
- welding devices and machines
- weld-in and weld-on saddles
- manifolds
- shut-off devices

Diameter __

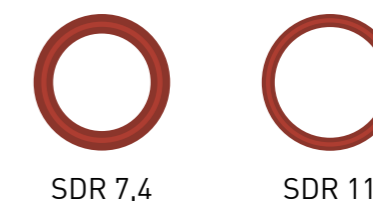
From the main line to the sprinkler/wall hydrant, aquatherm red pipes cover the complete piping system in the available diameters: 25, 32, 40, 50, 63, 75, 90, 110 and 125 mm (DN15 - 90).



Standard Dimension Ratio (SDR) __

The SDR (Standard Dimension Ratio) is a key figure indicating the pressure resistance. In order to guarantee a certain pressure resistance, a certain maximum SDR number is necessary, depending on the type of material. The following applies: The greater the wall thickness, the smaller the SDR number, the more pressure-resistant the plastic pipe is. The unit indicates the ratio between outer diameter and wall thickness of a pipe.

aquatherm red is available in the following SDR sizes:



Support intervals __

aquatherm red SDR 7.4									
Pipe diameter d [mm]									
25	32	40	50	63	75	90	110	125	
Support intervals [cm]									
140	160	180	205	230	245	260	290	320	

Table to determine support intervals in conjunction with outside diameter.



aquatherm red
**Characteristics and
special features**

AQUATHERM CHARACTERISTICS AND SPECIAL FEATURES

International Approvals ___

for the application as sprinkler lines

Fire protection requirements and standards for planning and construction of sprinkler systems vary locally.

Thus, the application of aquatherm red in any case has to be agreed and coordinated with the local national fire protection authorities, the constructor and the building insurers.

Further certification either national or local are in process.

UK; LPCB:

The system of pipes and fittings must be installed in accordance with the „Technical Instruction aquatherm red pipe“ dated 01/12/2012 Issue 2.

The current valid version of the „Technical Instruction aquatherm red pipe“ is available from infoservice@aquatherm.de.

aquatherm red Approvals ___



G4050042
Germany



Poland



Hong Kong



Austria



New Zealand

Brunamálastofnun

Iceland



FEDERAL STATE ESTABLISHMENT
THE ALL-RUSSIAN RESEARCH
INSTITUTE FOR FIRE PROTECTION
(FGU VNIPO)

Russia



Australian
Standard
AS 4118.2.1
Lic SMKP20464

Australia



LPS 1260
Cert.-no.: 684a

Great Britain



N.º 526/09

Spain



UkrSEPRO

Ukraine

AQUATHERM CHARACTERISTICS AND SPECIAL FEATURES

Handling

UV resistance:

Pipes from fusiolen® PP-R FS should not be installed (without protection) where subject to UV-radiation. All aquatherm red pipes and fittings are supplied in UV-protected packaging to bridge transport and assembly time. Ultraviolet rays have an influence on all high polymeric plastics. Hence, pipes should not be stored unprotected outside for a long time. The maximum storage time is (outside) 6 months.

Chemical resistance:

On account of the special material qualities aquatherm red pipes and fittings provide extensive chemical resistance. aquatherm red pipe transition connections and elements with brass inserts are not suitable for all media. The compatibility should be asked at aquatherm with media deviating from water. Please use the "Inquiry for the chemical resistance":

[↶ Chemical resistance](#)

Procedures for additional repair:

Cut out damaged/leaking section and replace as for a new installation or repair with pipe repair stick (page 49).

Pipe friction loss:

The pressure loss caused by friction is to be calculated hydraulically with the Hazen-Williams-formula. The value to be used for C is 150, applicable for calculations of sprinkler installations and water supply.

Equivalent lengths for the aquatherm red sprinkler pipe system

The equivalent lengths of transition pieces, threaded connexions and tees (flow direction: straight) can be edequated with the socket values.

Pipe dimension [mm]									
Nominal Diameter	DN 15	DN 20	DN 25	DN 32	DN 40	DN 50	DN 65	DN 80	DN 90
Outer diameter aquatherm red [mm]	25.0	32.0	40.0	50.0	63.0	75.0	90.0	110.0	125.0
Article									
Equivalent pipe length									
Socket	0.22	0.30	0.40	0.52	0.70	0.86	1.07	1.36	1.58
Reduction of 1 dimension	0.27	0.37	0.48	0.63	0.83	1.03	1.28	1.63	1.90
Reduction of 2 dimensions	0.36	0.49	0.64	0.84	1.11	1.37	1.71	2.17	2.53
Elbow < 90°-45°	0.67	0.91	1.20	1.57	2.09	2.57	3.20	4.07	4.74
Elbow < 45°	0.33	0.46	0.60	0.78	1.04	1.28	1.60	2.03	2.37
Standard tee or cross flow direction branch	0.98	1.34	1.76	2.30	3.06	3.76	4.70	5.96	6.96

Excerpt from the **Rockwool planning and installation aid** __

R 30- to R 90 pipe penetrations for the aquatherm installation systems with non-combustible media, such as drinking water, heating and cooling

**Product name/
Material:**

**aquatherm green
PP-R**
SDR 6 S
SDR 7,4 S
SDR 7,4 MF
SDR 7,4 MF UV
SDR 11 S

**aquatherm green
PP-RCT**
SDR 9 MF RP
SDR 9 MF RP UV

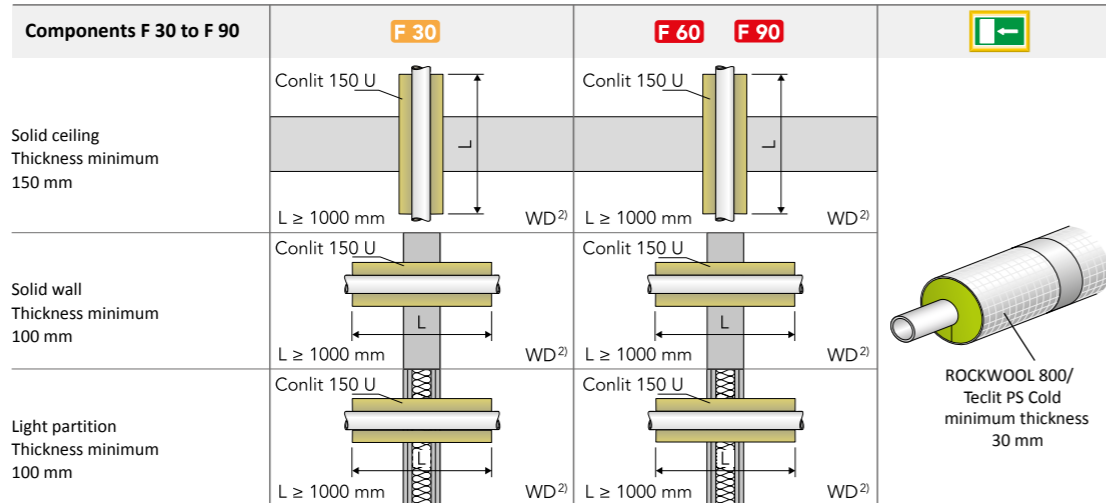
**aquatherm blue
PP-R**
SDR 7,4 MF
SDR 7,4 MF OT
SDR 7,4 MF UV
SDR 11 S

**aquatherm blue
PP-RCT**
SDR 9 MF RP
SDR 9 MF RP OT
SDR 9 MF RP UV
SDR 11 MF RP
SDR 11 MF RP OT
SDR 11 MF RP UV

**aquatherm red
PP-R (B1)**
SDR 7,4 MF HI

**aquatherm black
grid connection
pipe**

**aquatherm orange
PE-RT**



Variant according to ROCKWOOL abP P3726/4140MPA BS.

System	Pipe dimension Outer diameter Da [mm]	Conlit 150 U				ROCKWOOL 800 ^{1), 2), 3)} TECLIT PS Cold ^{1), 2), 3)}		
		GEG 50% ³⁾ d/d [mm]	Core drilling DK [mm]	GEG 100% ³⁾ d/d [mm]	Core drilling DK [mm]	BSU ⁴⁾ d/d [mm]	GEG 50% ¹⁾ d/d [mm]	GEG 100% ¹⁾ d/d [mm]
pipes without OT or UV layer	14,0	14/23	60	15/42,5	100	15/30	15/20	15/20
	16,0	16/22	60	16/42	100	18/30	18/20	18/20
	17,0	17/21,5	60	18/41	100	18/30	18/20	18/20
	20,0	20/20	60	20/40	100	22/30	22/20	22/20
aquatherm green	25,0	25/17,5	60	25/37,5	100	28/30	28/20	28/20
aquatherm blue	26,0	26/17	60	28/51	130	28/30	28/20	28/20
aquatherm red	32,0	32/24	80	32/49	130	35/30	35/20	35/30
aquatherm grey	40,0	40/20	80	40/45	130	42/30	42/20	42/40
aquatherm black	50,0	50/25	100	50/50	150	54/30	54/30	54/40
aquatherm orange	63,0	63/33,5	130	63/58,5	180	64/30	64/30	64/50
	75,0	75/52,5	180	75/62,5	200	76/70	76/40	76/70
	90,0	90/65	220			102/30	102/40	102/80
	110,0	110/70	250			114/30	114/50	114/100
pipes without OT or UV layer	16,0	18/21	60	18/41	100	18/20	18/20	18/20
	20,0	22/19	60	22/39	100	22/30	22/20	22/20
	25,0	27/16,5	60	28/51	130	28/30	28/20	28/20
	32,0	34/23	80	35/47,5	130	35/30	35/20	35/30
aquatherm green UV	40,0	42/19	80	42/54	130	42/30	42/20	42/40
aquatherm blue OT + UV	50,0	53/23,5	100	54/53	160	54/30	54/30	54/40
	63,0	64/33	180	64/58	180	76/30	76/30	76/50
	75,0	71/51,5	180	76/62	200	89/30	89/40	89/70
	90,0	90/65	220			102/80	102/40	102/80
	110,0	113/53,5	220			114/30	114/50	114/100

Notes/special installation conditions

- 1) Minimum insulation thickness required in conjunction with pipe penetration seals in accordance with abP P-3726/4140-MPA BS; thermal insulation requirements in accordance with GEG are also met.
- 2) The insulation shell ROCKWOOL 800 or Teclit PS Cold can be used as additional insulation.
- 3) For correct dimensioning of the insulation thickness for pipework with cold media, please follow the instructions in our Teclit cold insulation pipe work installation instructions.
- 4) In the area of escape routes, fire load encapsulation with ROCKWOOL 800 or Teclit PS Cold (insulation thickness: 30 mm) can be used.

All boundary conditions of the specified general building inspectorate test certificates (abP) or general type approvals (aBG) must be taken into account.



Roku System AWM II



Rockwool Conlit 150 U

Fire load __

The values required for determining the fire load within a fire section are calculated from the total of all flammable materials located within this area. The calculation for establishing the combustion heat V [kWh/m] for a fire section in the event of an outbreak is dependent on dimensions and materials. The basis used for the calculation of pipe systems made of polypropylene is the lower calorific value $H_u = 12.2 \text{ kWh/kg}$ (as per DIN V 18230 T1) in conjunction with the mass of material m_{pipe} [kg/m]. The integrated layers of fibres in the aquatherm fibre composite pipes are also considered.

Depending on the calculation procedure, the fire load is worked out with reference to the burn-up factor. This value is designated as m_{factor} and is taken as 0.8 for polypropylene.

Fire compartmentalisation __

All fire protection systems that have the appropriate approval are suitable for aquatherm red pipework.

Combustion values V [kWh/m] for aquatherm red SDR 7.4 __

Dimension	kWh/kg
25 mm	2.69
32 mm	4.32
40 mm	6.73
50 mm	10.48
63 mm	16.46
75 mm	23.42
90 mm	33.55
110 mm	50.19
125 mm	64.63

The following companies offer **suitable fire protection solutions**: __

Fire protection pipe shell Conlit 150 U:
DEUTSCHE ROCKWOOL GmbH & Co. KG
Rockwool Straße 37-41
45966 Gladbeck
Tel: +49 2043 408 0
www.rockwool.de

Fire protection sleeve AWM II:
Flamro Brandschutz Vertriebs GmbH
Am Sportplatz 2
56291 Leiningen
Tel: +49 6746 9410-0
Mail: info@flamro.com
www.flamro.de

Hilti Deutschland AG · Hiltistrasse 2 · 86916 Kaufering
Tel: +49 800 888 · www.hilti.de

AQUATHERM CHARACTERISTICS AND SPECIAL FEATURES

Material fusiolen® ___

aquatherm red is made of corrosion-resistant material. This considerably extends the service life of the pipeline, for example for an air conditioning system. The material of aquatherm is characterized among other things by its special high heat and extraction

stability. Due to the exceptionally good welding properties, pipe and fitting fuse to form a homogeneous, materially bonded unit; this has made the material fusiolen® famous worldwide.



The advantages of aquatherm pipes and fusiolen® polypropylene ___

- corrosion resistant
- resistant against many chemicals
- high environmental compatibility
- less pipe roughness
- heat and sound insulating characteristics
- high mechanical stability
- very good welding properties
- high heat-stabilised
- lighter in weight than steel and copper
- easy processing

Our material fusiolen® Polypropylene ___

Newly opened markets place ever increasing demands on the pipe material. Versatile applications require the greatest possible independence of the processed materials. Raw materials with novel properties that could not be achieved until then are required. For this reason, aquatherm has been developing and producing its own innovative polypropylene materials for several years, which meet the global challenges in sanitary and heating technology, in air-conditioning and refrigeration technology, in industrial applications and agriculture, in shipbuilding, and in fire protection.

Successful results of this research are fusiolen® PP-R, fusiolen® PP-RCT and fusiolen® PP-R FS.

Environment ___

The environmentally friendly material polypropylene fusiolen® PP-R/PP-RCT is recyclable and can be ground, melted and reutilised for various applications e.g. motor-protections, wheel linings, laundry baskets and other kinds of transport boxes. There are no polluting substances with PP-R/PP-RCT either in its processing or in its disposal.

Higher long-term heat stabilisation ___

The long-term heat stabilisation has been increased to resist to the potential effects of peak temperatures within higher safety parameters.





AQUATHERM CHARACTERISTICS AND SPECIAL FEATURES

This is how aquatherm is committed ___

17 goals to change the world: In 2015, the global community developed the „Agenda 2030“, a roadmap for the future.

This is intended to enable a dignified life world-wide and to preserve the natural foundations of life in the long term. We at aquatherm would like to contribute to the achievement of these goals with all our actions. Our sustainable products,

our comprehensive service and our leading expert knowledge are part of the solution on the way to a climate-neutral life.

We are also a member of the German Sustainable Building Council (DGNB e.V.) and work with the non-profit organisation to find ways and solutions to build for tomorrow today.

Climate change ___

Climate change is one of the greatest challenges of our time. Released CO₂ is the main problem: it enters the atmosphere and intensifies the greenhouse effect - the earth continues to heat up.

We are convinced that we humans will find solutions to meet this challenge and thus also significantly reduce CO₂ emissions in all sectors.

Construction industry ___

The construction industry is responsible for 36% of global energy consumption and 39% of energy- and process-related CO₂ emissions.*

The construction industry has already begun to face up to this responsibility. In order to achieve the final goal of a “net zero building” over the entire life cycle, the but the steps are still too small.

More courageous and visionary pioneers are needed, who will show the right way and set an example for the entire industry.

Exceptionally environmentally friendly ___

The European Plastic Pipe Association TEPPFA analysed the environmental impact of plastic pipe systems as part of its EPD project. The result: plastic pipe systems have excellent environmental performance in various areas of application, leaving a smaller ecological footprint than pipe systems made of other materials.

A pipe system made of polypropylene (25 mm, SDR 7.4), for example, has approximately seven times lower CO₂ emissions than a comparable steel pipe.

Success through consistent environmental protection ___

We live environmental protection – and do so consistently. All corporate processes are geared to conserving valuable resources, minimising energy use, and avoiding or recycling waste.

We developed the first fibre composite pipe as early as 1999. This required significantly less energy in the production process than the conventional aluminium composite pipe.

Technical data sheet ___

Technical properties	fusiolen® PP-R	fusiolen® PP-R/PP-RCT fibrepipe
Melt-flow index 190 °C/5 kg	0.5 g/10 min.	0.5 g/10 min.
Melt-flow index 230 °C/2.16 kg	0.3 g/10 min.	0.3 g/10 min.
Modulus of elasticity	800 N/mm ²	1200 N/mm ²
Yield stress	25 N/mm ²	30 N/mm ²
Density	0.9 g/cm ³	1.0 g/cm ³
Tensile strength	25 MPa	35 MPa
Inflammation temperature	430-450 °C	490-500 °C
Thermal expansion coefficient	1.5 *10 ⁻⁴ K ⁻¹	0.35 *10 ⁻⁴ K ⁻¹
Coefficient of thermal conduction	0.15 W/mK (measured at pipe)	0.15 W/mK (measured at pipe)
Coefficient of friction in pipes	0.007	0.007
Bending radius	6 x d	
Water absorption	< 0.02 %	< 0.02 %
Electrical properties	fusiolen® PP-R	fusiolen® PP-R/PP-RCT fibrepipe
Relative permittivity	2.3 (in case of 1 MHz)	2.3 (in case of 1 MHz)
Puncture voltage	500 kV/cm	500 kV/cm
Specific resistance	> 10 ¹⁷ Ω cm	> 10 ¹⁷ Ω cm
Surface resistance	10 ¹⁴ Ω	10 ¹⁴ Ω
Dissipation coefficient	0.0002 (in case of 50 Hertz)	0.0002 (in case of 50 Hertz)

AQUATHERM CHARACTERISTICS AND SPECIAL FEATURES

aquatherm **Environmental Product Declaration** ___

What is an **Environmental Product Declaration**? ___

An Environmental Product Declaration (EPD) describes the environmental impact of a product or service on the environment. It records the consumption of resources and emissions over the entire life cycle of the product - from the extraction of raw materials to disposal - and quantifies and evaluates them. Therefore, an Environmental Product Declaration offers the possibility to compare different products with each other.

In the Environmental Product Declaration, the characteristics of a product are identified neutrally using internationally recognised standards. A precise methodology according to ISO 14025 and EN 15804 is followed, and all values are checked by independent third parties regarding their completeness, plausibility, and conformity with standards.

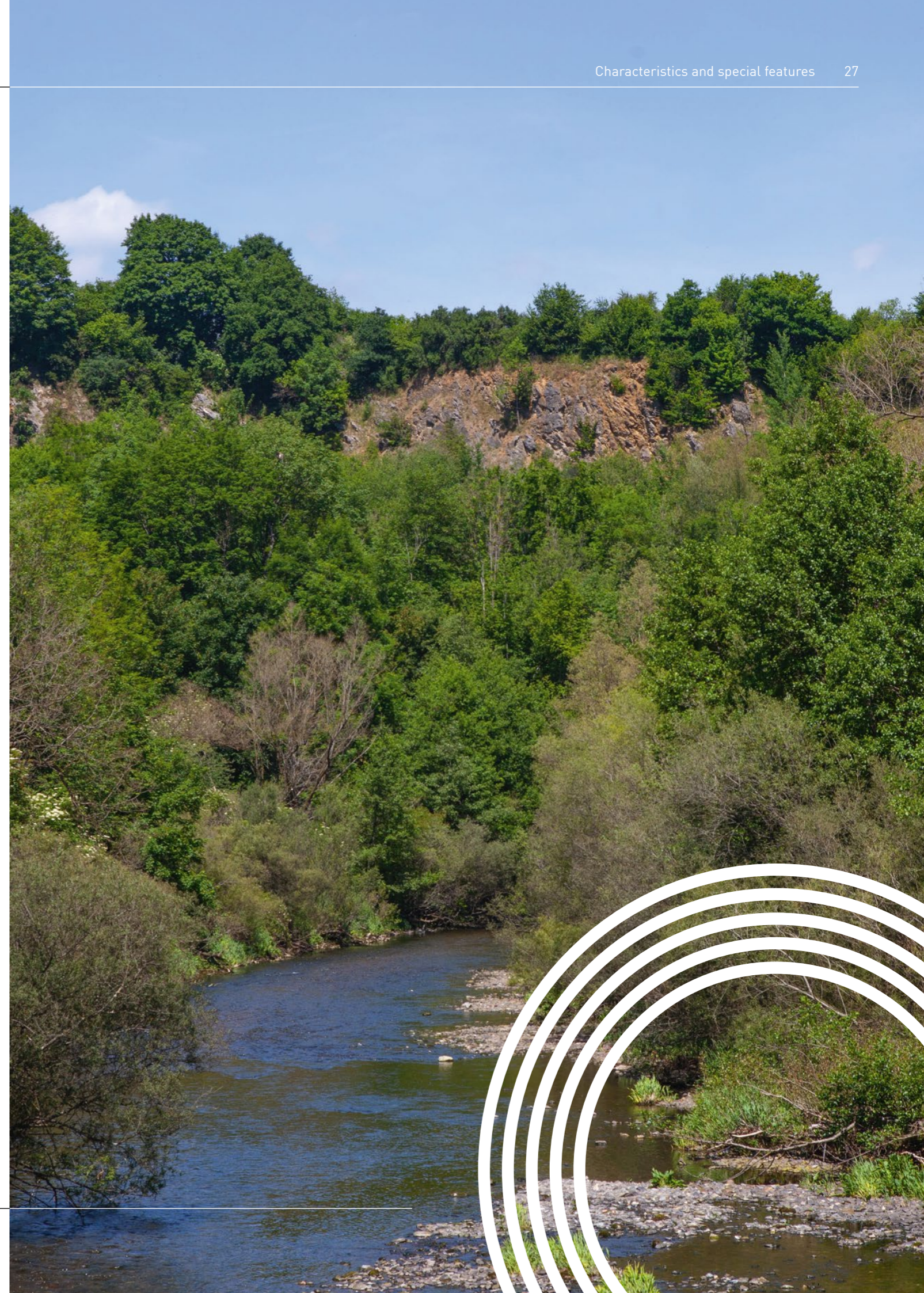
However, the EPD is not a certificate, i.e. there are requirements placed on the quality and format of the data, but not on the quality of the product. For the building sector, it forms an important basis for the ecological assessment of buildings.

What are **product category rules**? ___

To be able to evaluate functionally similar products in the same way and in the context of an Environmental Product Declaration, Product Category Rules (PCRs) are used. These are a set of specific rules, requirements or guidelines according to which products are classified into groups. Product Category Rules exist, for example, for thermal insulation materials, windows and doors, or building piping systems.

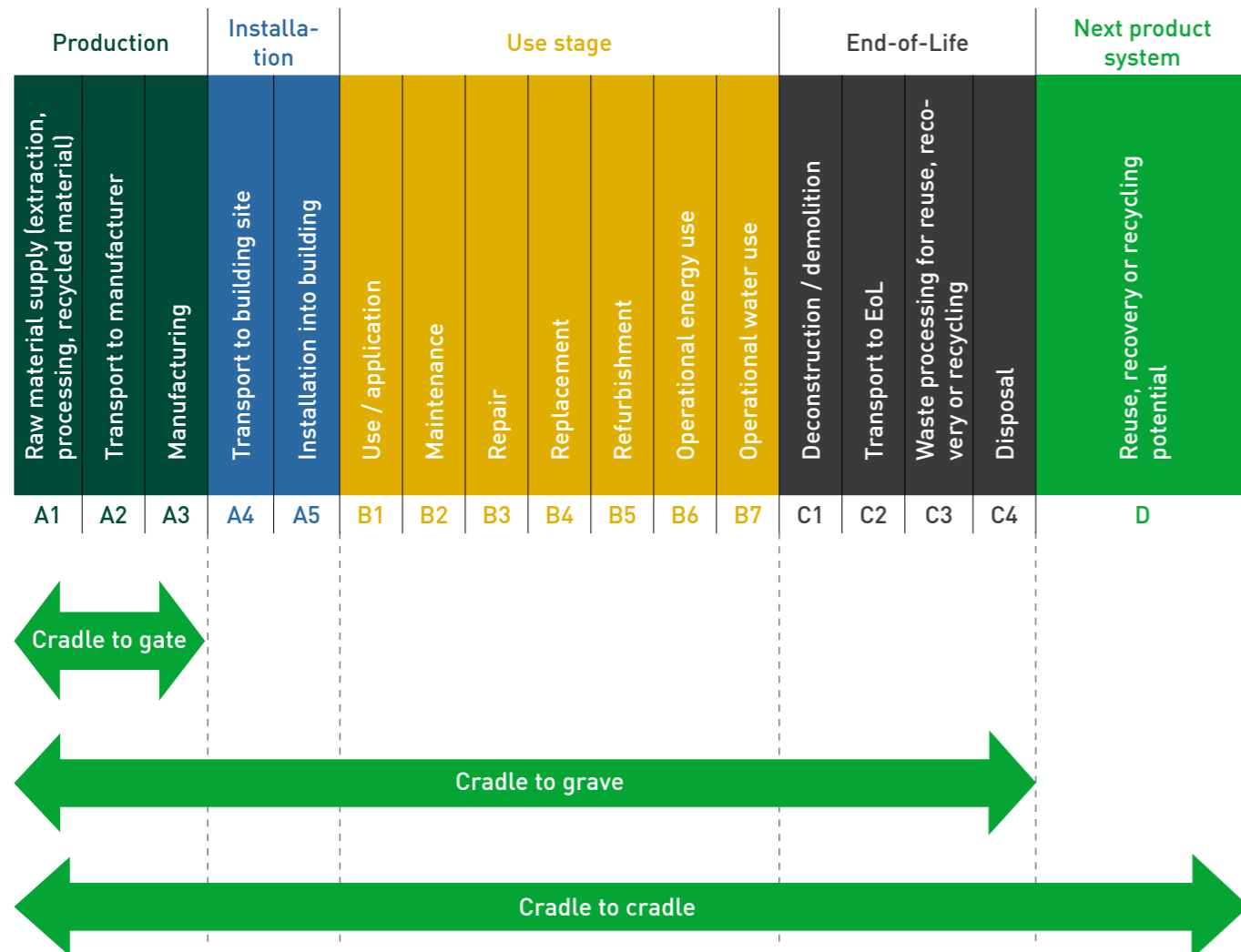
What is a **Life Cycle Assessment**? ___

The aim of a Life Cycle Assessment (LCA) is not only to provide environmentally relevant data on specific products, but also to estimate potential environmental issues which then can assist in making a decision for or against a particular product. The basis of the Life Cycle Assessment is the life cycle of a product. It consists of different phases: Raw material extraction, material production, use, waste treatment and final disposal. All environmental inputs and outputs are listed. In other words, everything that flows into and out of the product is measured. These can be raw materials or resources, different types of energy, water or emissions into the air, soil or water.



What does the Product life cycle include? __

A life cycle assessment considers either the entire life cycle of a product or parts of it. Therefore, there are three different approaches to assessing the product life cycle:



What are the environmental impact indicators? __

Life Cycle Assessments provide information on the potential impact of a product (or service) on the environment. EN 15804+A2 describes 13 core Environmental Impact Indicators to be reported for an Environmental Product Declaration and 6 additional optional Environmental Impact Indicators.

Core indicators according to EN 15804+A2:

Core indicator	Unit
GWP-total	kg CO ₂ -Äq.
GWP-fossil	kg CO ₂ -Äq.
GWP-biogenic	kg CO ₂ -Äq.
GWP-luluc	kg CO ₂ -Äq.
ODP	kg CFC11-Äq.
AP	mol H ⁺ -Äq.
EP-freshwater	kg PO ₄ -Äq.
EP-marine	kg N-Äq.
EP-terrestrial	mol N-Äq.
POCP	kg NMVOC-Äq.
ADPE	kg Sb-Äq.
ADPF	MJ
WDP	m3 World-Äq. withdrawn

Legend
 GWP = Global warming potential
 ODP = Stratospheric ozone depletion potential
 AP = Acidification potential of soil and water
 EP = Eutrophication potential
 POCP = Potential for formation of tropospheric ozone
 ADPE = Potential for depletion of abiotic resources - non-fossil resources (ADP - substances)
 ADPF = Potential for depletion of abiotic resources - fossil fuels (ADP - fossil fuels)
 WDP = Water depletion potential (users)

Additional impact categories according to EN 15804+A2-optional:

Indicator	Unit
PM	Illness cases
IR	kBq U235-Äq.
ETP-fw	CTUe
HTP-c	CTUh
HTP-nc	CTUh
SQP	-

Legend
 PM = Potential incidence of disease due to particulate matter emissions.
 IR = Potential effect from human exposure to U235
 ETP-fw = Potential toxicity comparison unit for ecosystems
 HTP-c = Potential toxicity comparison unit for humans (carcinogenic effect)
 HTP-nc = Potential toxicity comparison unit for humans (non-carcinogenic effect)
 SQP = Potential soil quality index

How reliable is an Environmental Product Declaration? __

Neutral and in accordance with internationally recognised standards: This is how the characteristics of a product are recorded in an Environmental Product Declaration. The exact methodology follows ISO 14025 and EN 15804, and all values are verified by independent third parties. The Environmental Product Declaration is valid for a period of five years. If there are changes in the manufacture of the product during this period, leading to major deviations from the previous values, a review must be carried out.

What advantages does the Environmental Product Declaration offer me? __

Environmental Product Declarations enable companies, for example, to participate in public tenders or investors to have their building's sustainability systems, such as BREEAM, LEED or DGNB, in place. In addition, an Environmental Product Declaration forms the basis for the development and optimisation of sustainable products.

aquatherm Environmental Product Declaration __

Environmental Product Declarations are important - for the construction industry, for us, and our customers. That is why we have had our products evaluated according to the „cradle to gate“ concept.

Our Environmental Product Declarations



are available for the following product group:

- aquatherm green/blue S/MF pipe
- aquatherm red pipe S/MF
- aquatherm black system
- aquatherm green/blue S/MF pipe (OT)
- aquatherm green/blue S/MF pipe (UV)
- aquatherm green/blue S/MF pipe (TI)



aquatherm red
Fusion



FUSION

Processing

There are many possibilities for the connection of aquatherm red piping systems. With the fusion techniques of aquatherm you quickly create a permanently tight connection.



Welding techniques

Due to their exceptionally good welding properties, pipe and fitting fuse to form a homogeneous, materially bonded unit. For this purpose, the pipe and fitting are briefly heated with the aid of tools provided for this purpose and then simply joined together; that's it! Double material thickness at the joint - this means double safety at the otherwise critical point of a piping system.

Socket welding

A safe and fast connection in the socket welding process is possible with our manual welder for pipes with dimensions of 20 to 63 mm.

[▶ view video](#)

Socket welding with welding machine

With pipe dimensions from 50 to 125 mm, our aquatherm welding machines ensure a safe and durable connection.

[▶ view video](#)

Weld-in saddle

Branches in aquatherm red can be produced very easily, even retrospectively, using weld-in saddles. The use of weld-in saddles also reduces the amount of material and time required.

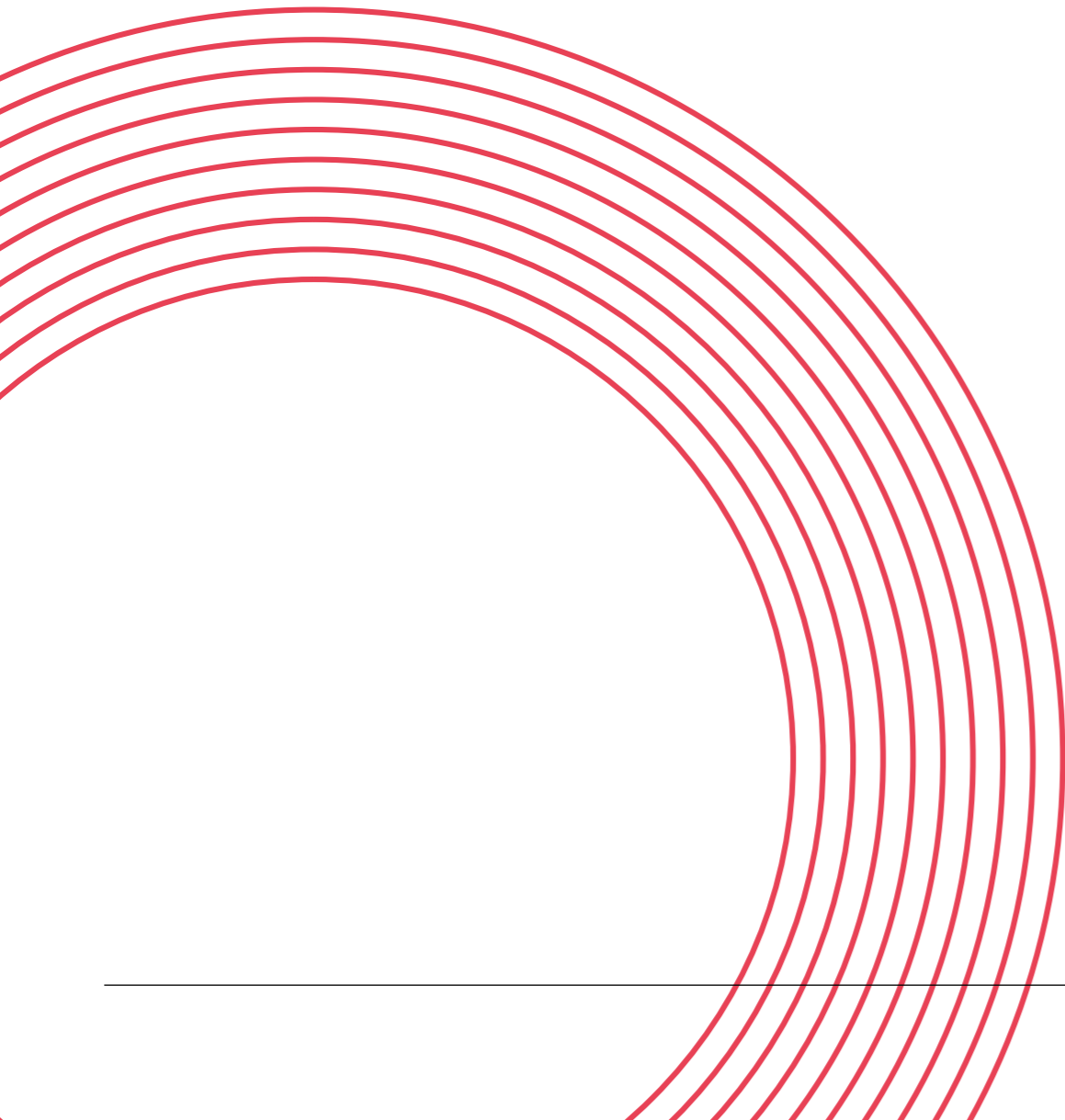
[▶ view video](#)

Electric welding jig

Electric socket welding (heating coil welding) is suitable in hard-to-reach areas for pipes with dimensions of 63 to 125 mm.

[▶ view video](#)



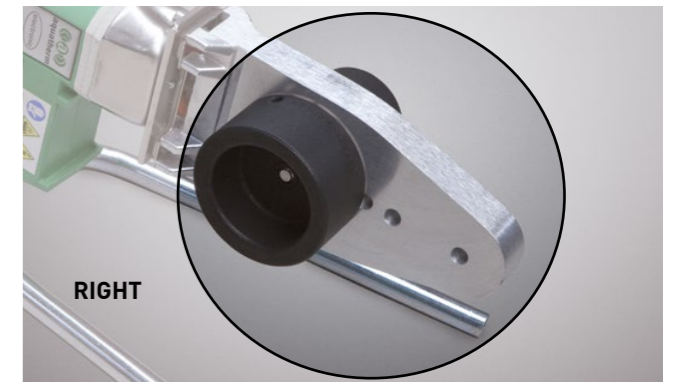


FUSION

PART A: Mounting of the welding tools __

- 1. Important!**
Only use original aquatherm welding devices and aquatherm welding tools.
- 2.** Assemble and tighten the cold welding tools manually.
- 3.** All welding tools must be free from impurities. Check, if they are clean before assembling. If necessary, clean the welding tools with a nonfibrous, coarse tissue and with spirit.
- 4.** Place the welding tools, so that there is full surface contact between the welding tool and the welding plate. Welding tools over \varnothing 40 mm must always be fitted to the rear position of the welding plate.
- 5.** Plug in the welding device and check, if operating lamp is on. Depending on the ambient temperature it takes 10–30 minutes to heat-up the welding plate.

The heat-up phase ends, when the temperature pilot lamp blinks and a signal is audible.

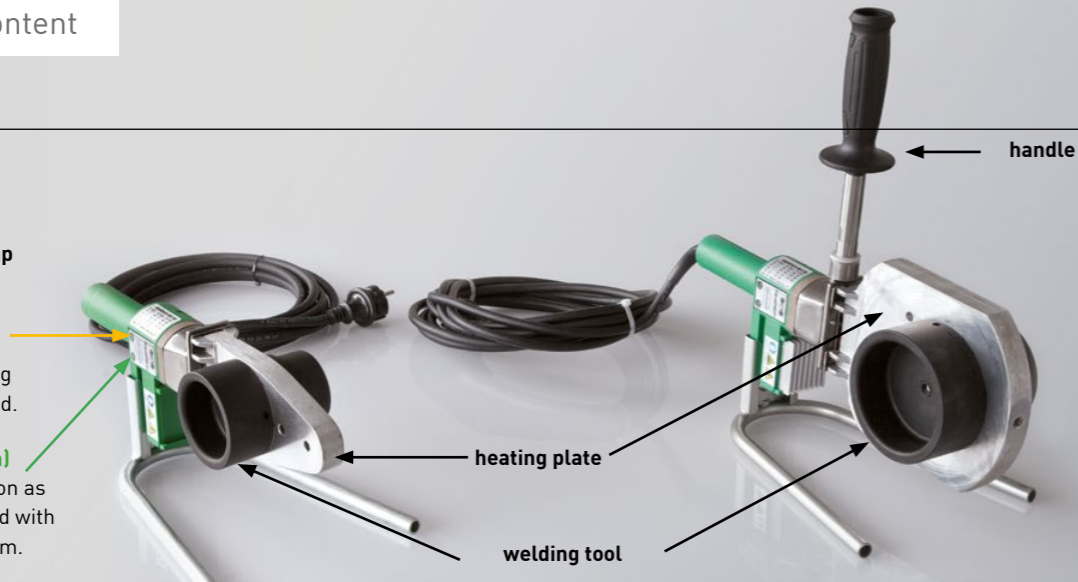


Temperature pilot lamp (yellow)

glows constantly while the heatup phase and blinks when the welding temperature is achieved.

Operating lamp (green)

glows constantly as soon as the device is connected with the power supply system.



Assembly of the welding tools

6. During the heat-up phase tighten the welding tools carefully with the Allen Key. Take care that the tools fully contact the welding plate. Never use pliers or any other unsuitable tools, as this will damage the coating of the welding tools.

7. The required temperature to weld the aquatherm red pipe system is 260 °C. Acc. to DVS-Welding Guidelines, the temperature of the welding device has to be checked at its tool before starting the welding process. This has to be done with a fast indicating thermometer or alternatively with an aquatherm thermocolour crayon. (see "Fusion part B, item 2")

Attention: First welding at the earliest 10 minutes after reaching the welding temperature DVS 2207, Part 11

8. A tool change on a heated device requires another check of the welding temperature at the new tool (after heat-up phase).

9. If the device has been unplugged, i. e. during longer breaks, the heatup process has to be restarted (from item 5).

10. After use unplug the welding device and cool down. Water must never be used to cool the welding device, as this would destroy the heating resistances.

Handling

11. Protect aquatherm welding devices and tools against impurities. Burnt particles may result in an incorrect fusion.

The tools may be cleaned with aquatherm cleaning wipes, Art. no. 9800050193. Always keep the burnt-in welding tools dry. If necessary, dry them with a clean, nonfibrous tissue.

12. For perfect fusion, damaged or dirty welding tools must be replaced, as only undamaged tools ensure a perfect fusion welding.

13. Never attempt to open or repair a defective device. Return the defective device for repair.

14. Check the operating temperature of the aquatherm green pipe welding devices regularly by means of suitable measuring instruments.

Guidelines

15. For the correct handling of welding machines the following must be observed: General Regulations for Protection of Labour and Prevention of Accidents and particularly the Regulations of the Employers' Liability Insurance Association of the Chemical Industry regarding Machines for the Processing of Plastics, chapter: „Welding Machines and Welding Equipment“.

16. For the handling of the aquatherm welding machines, devices and tools please observe General Regulations DVS 2208 Part 1 of the German Association for Welding Engineering, Registered Society (Deutscher Verband für Schweißtechnik e. V.).

[View video](#)

Checking of devices and tools

1. Check, if the aquatherm welding device and tool correspond to the guidelines "Fusion Part A".

2. All devices and tools in use must have reached the required operating temperature of 260 °C in use. This needs a separate, compulsory test, acc. to DVS-Welding Guideline. The control of the operating temperature can be made with fast indicating thermometers.

Note:

aquatherm recommends the original aquatherm temperature measuring device art. no. 9800050188.

Alternatively it is also possible to check the welding temperature with the aquatherm thermocolour crayon. The application of the special thermocolour chalk in the aluminium crayon enables an exact reading with a tolerance of +/- 5 K to heated surfaces.

Application:

After the temperature pilot lamp of the welding device has indicated the end of the heat-up period, put a firm chalk line on the heated external surface of the welding tool. The colour must change within 1–2 seconds. If the temperature is too high, the colour will change immediately and if it is too low (below 260 °C) it will change after 3 or more seconds.

If the colour does not change within 1–2 seconds, another temperature test has to be carried out, respectively the control of the welding device is required.



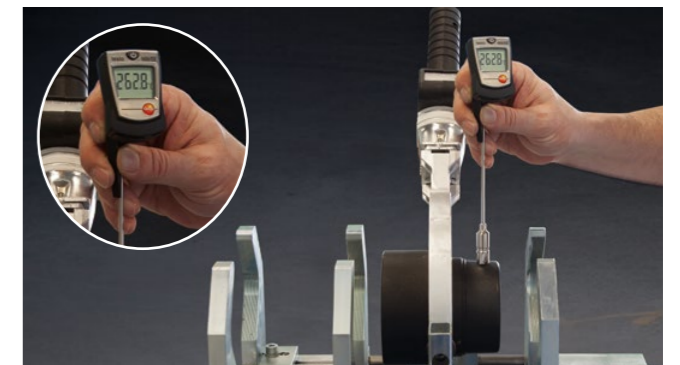
aquatherm temperature measuring device art. no. 9800050188



Measurement of temperature at the aquatherm manual welding device (800 W).



Temperature control aquatherm welding device (1400 W)



Temperature control aquatherm welding machine



Temperature control with the aquatherm thermocolour crayon

FUSION

PART B: Preparation for the fusion __

3. Cut the pipe right-angled to the pipe axis.

Only use aquatherm pipe cutters or other suitable cutting tools. Take care that the pipe is free from burrs or cutting chips and remove if necessary.

4. Mark the welding depth at the end of the pipe with the enclosed pencil and template.

5. Mark the desired position of the fitting on the pipe and/or fitting.

The auxiliary markings on the fitting and the continued line on the pipe may be used as a help.



Cutting of the pipe



Marking of the welding depth

The fusion is subject to the following data:

Pipe external-Ø	Welding depth	Heat-up time	Welding time	Cooling time
mm	mm	sec. DVS	sec	min
25	16.0	7	4	2
32	18.0	8	6	4
40	20.5	12	6	4
50	23.5	18	6	4
63	27.5	24	8	6
75	30.0	30	8	8
90	33.0	40	8	8
110	37.0	50	10	8
125	40.0	60	10	8

The General Guidelines for Heated Socket Welding acc. to DVS 2207 Part 11 apply.



Warming

Joining, fixing and ...

... aligning!

Heat-up of pipe and fittings __

6. Push the end of the pipe, without turning, up to the marked welding depth into the welding tool and at the same time the fitting, without turning, as far as it will go on the tool. It is essential to observe the above mentioned heating times.

Pipes and fittings of the dimensions Ø 75 to 125 mm may only be welded with welding device Art. no. 9800050341 (or with machine Art. no. 9800050148). On using the aquatherm green pipe welding machine Art. no. 9800050148, a separate operating instruction has to be observed.

Attention:

The heating time starts, when pipe and fitting have been pushed with the correct welding depth on and in the welding tool. Not before!

Setting and alignment __

7. After the stipulated heat-up time quickly remove pipe and fitting from the welding tools. Join them immediately, without turning, until the mark welding depth is covered by PP-bead of the fitting.

Attention:

Do not push the pipe too far into the fitting, as this would reduce the bore and in an extreme case may close the pipe.

8. The joint elements have to be fixed during the specified processing time. Use this time to correct the connection. Correction is restricted to the alignment of pipe and fitting. Never turn the elements or align the connection after the processing time.

9. After the cooling period the fused joint is ready for use.

The result of the fusion of pipe and fitting is a permanent material joining of the system elements.

Unrivalled connection technique with security for a life-time!

Visual inspection of fusion seam __

Normally on fusioning a bead is formed around the entire circumference at the edge of the socket. This bead is an indication of proper welding.

Incorrect shape of bead

1 Different shape of bead (b) or non-existent bead at one or at both ends (a) (partial or total extent), resulting from:

- Temperature of heating tool is too low (a)
- Heat-up time too short (a)
- Unacceptable tolerances (a and b)
- Excessive temperature of heating tool (b)
- Heat-up time too long (b)

2 Single shape of bead resulting from:

- Heat-up time too short
- Temperature of heating tool is too low
- Unacceptable tolerances
- Heat-up of only one welding part

3 Excessive melting, resulting from:

- Temperature of heating tool is too high
- Misaligned movement of welding-part, e.g. by inadequate fixing
- Unacceptable tolerances

4 Elbow variance
Partially or double-sided inclined welded pipe into the socket without or with slight bracing, resulting from:

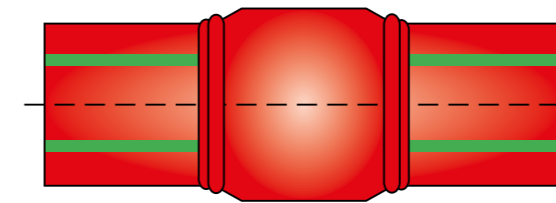
- Machinery defect
- False installation

Acceptable, if $e \leq 2 \text{ mm}$

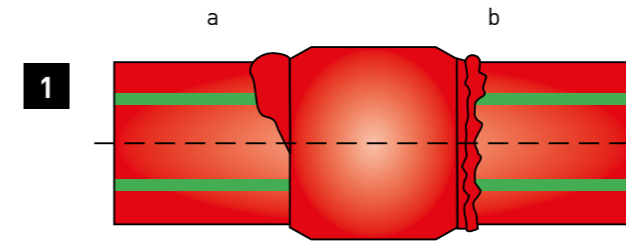
5 Mistake of bonding by improper pipe insertion, resulting from:

- Heat-up time too short
- Pipe ends not at 90° (right-angled)
- Heating temperature too low
- Axial movement during cooling time
- Change-over time too long

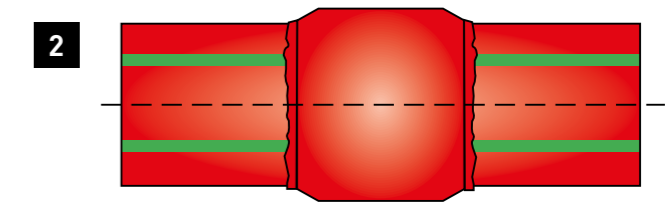
Acceptable up to $0.1 \times d$ and $0.15 \times$ socket depth



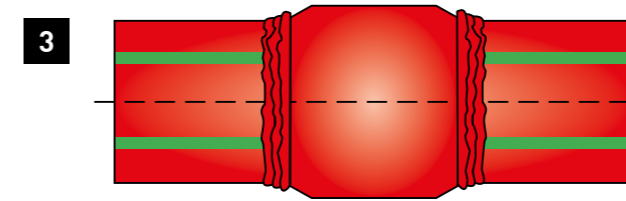
correct fusion welding



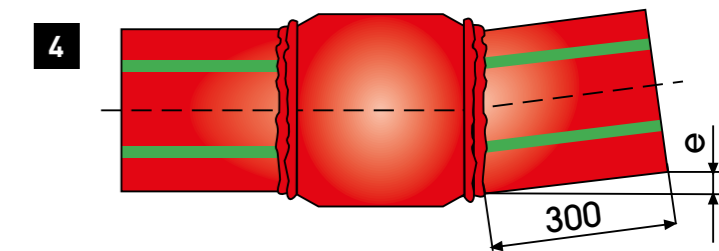
1



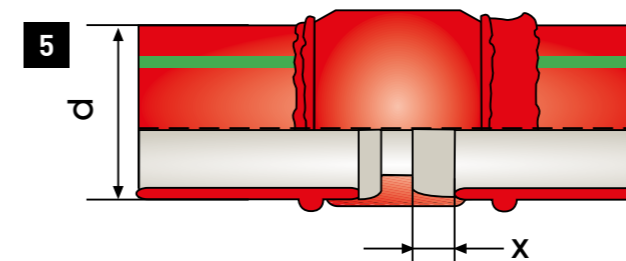
2



3



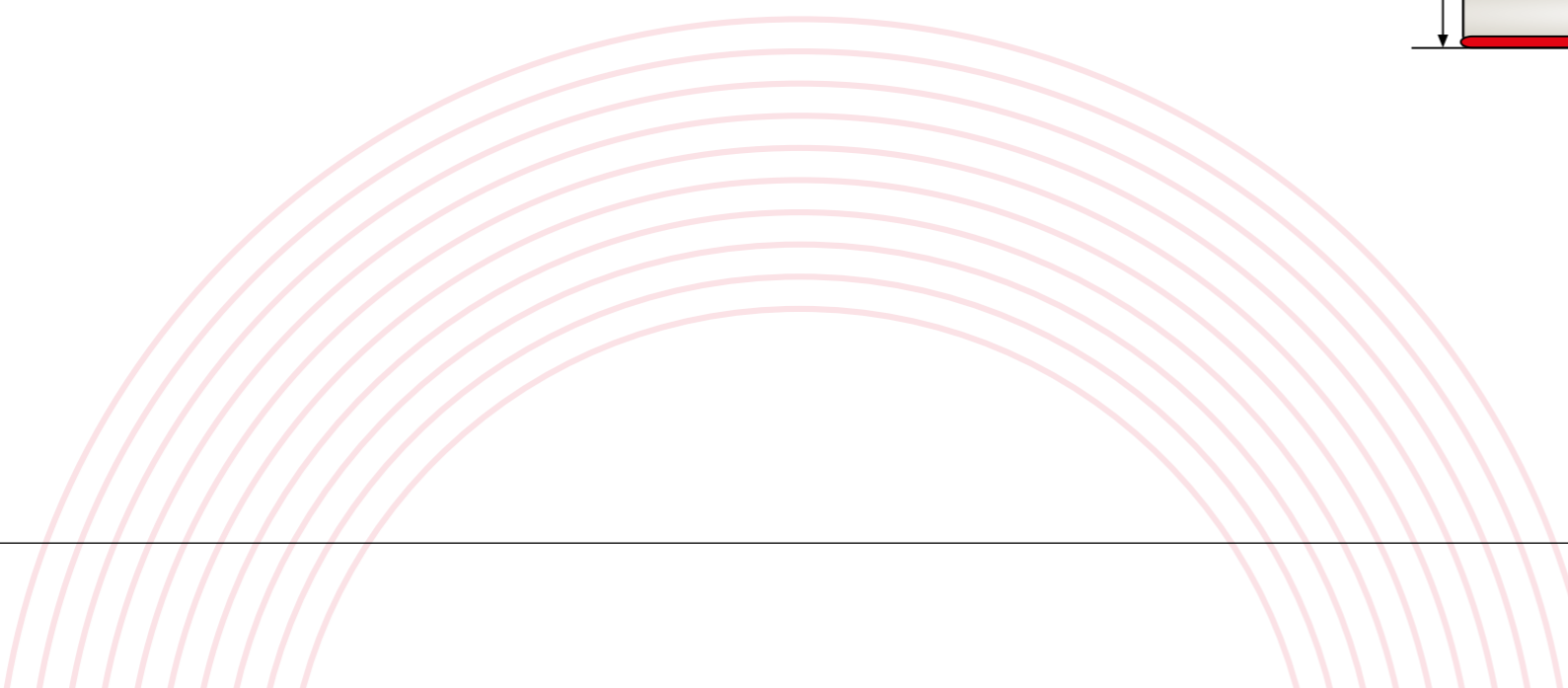
4



5

The visual inspection may be only a first indication of the welding seam quality. But it is not a replacement for the leak test, which has to be carried out after the completion of the installation.

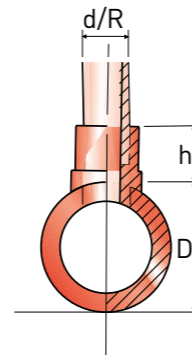
Source: DVS 2202-1, to purchase at DVS-publisher, Düsseldorf Copyright Publisher for fusion and related procedures DVS-Verlag GmbH



FUSION

PART C: Weld-in saddles __

For pipe external diameters of 63, 75, 90, 110, 125 mm



Art. no.	D	d	R	h	Sensorwells	Drill	Welding Tool
	mm	mm	IG.	mm	ø mm	Art. no.	Art. no.
3030063001	63	32	IG.	30.0	-	9800050942	9800050620
3030075002	75	32	-	30.0	-	9800050942	9800050624
3030075003	75	40	-	34.0	-	9800050944	9800050625
3030090004	90	32	-	30.0	-	9800050942	9800050628
3030090005	90	40	-	34.0	-	9800050944	9800050629
3030110006	110	32	-	30.0	-	9800050942	9800050632
3030110007	110	40	-	34.0	-	9800050944	9800050634
3030110008	110	50	-	34.0	-	9800050946	9800050635
3030125009	125	32	-	30.0	-	9800050942	9800050638
3030125010	125	40	-	34.0	-	9800050944	9800050640
3030125011	125	50	-	34.0	-	9800050946	9800050642
3030125012	125	63	-	38.0	-	9800050948	9800050644
3030040021	40	-	-	39.0	14	9800050940	9800050614
3030050022	50	-	1/2"	39.0	14	9800050940	9800050616
3030063002	63	-	1/2"	39.0	14	9800050940	9800050619
3030075001	75	-	1/2"	39.0	14	9800050940	9800050623
3030075023	75	-	1/2"	43.0	20	9800050942	9800050624
3030090024	90	-	1"	43.0	20	9800050942	9800050628
3030110025	110	-	1"	43.0	20	9800050942	9800050632
3030125026	125	-	1"	43.0	20	9800050942	9800050638

Drilling, heating, joining & fixing __

1. Before starting the welding process, check if the aquatherm welding devices and tools meet the requirements of "Fusion Part A".
2. The first step is to drill through the wall of the pipe at the point intended for the outlet by using the aquatherm drill.
branch 25 mm: Art. no. 9800050940
branch 32 mm: Art. no. 9800050942
branch 40 mm: Art. no. 9800050944
branch 50 mm: Art. no. 9800050946
branch 63 mm: Art. no. 9800050948
branch 75 mm: Art. no. 9800050940
branch 90 mm: Art. no. 9800050940

3. The welding device/saddle welding tool must have reached the required operating temperature of 260 °C (check with reference to "Fusion Part B, item 2").

4. The welding surfaces have to be clean and dry.

5. Insert the heating tool on the concave side of the weld-in saddle tool into the hole drilled in the side wall of the pipe until the tool is completely in contact with the outer wall of the pipe. Next the weld-in saddle spigot is inserted into the heating sleeve until the saddle surface is up against the convex side of the welding tool. The heating time of the elements is generally 30 seconds.

6. After the welding tool has been removed, the weld-in saddle spigot is immediately inserted into the heated, drilled hole. The weld-in saddle should then be pressed on the pipe for about 15 seconds. After being allowed to cool for 10 minutes, the connection can be exposed to its full loading. The appropriate branch pipe is fitted into the sleeve on the aquatherm weld-in saddle using conventional fusion technology.

By fusing the weld-in saddle with the pipe outer surface and the pipe inner wall, the connection reaches highest stability.

[▶ View video](#)



Drilling through the pipe wall



Heat-up of pipe ...



... and fitting



Joining

FUSION

PART D: Welding jig (hitch) __

Note

The following description of the electric welding jig applies to the type of the year 2013.

Operation and fusion

With the help of the electric welding jig, all aquatherm polypropylene pipes and fittings in dimensions from 63 to 125 mm are in a very simple manner without any effort welded together.

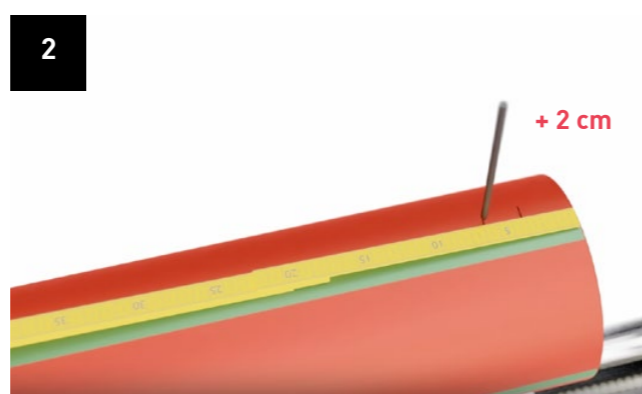
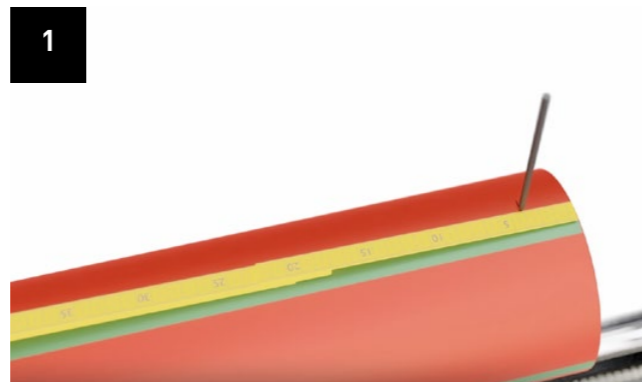
The welding jig simplifies the welding of pipes and fittings under ceilings, in narrow shafts and other hard-to-reach places.

For welding aquatherm red, a welding temperature of 260 °C on the welding tool is required (see page 37).

Preparation for the fusion

Mark the welding depth with the included green marking template on the pipe end. (Fig. 1). In addition, the clamping depth is measured 2 cm from the welding depth marking and marked again. (Fig. 2)

[▶ View video](#)



Preparation for fusion

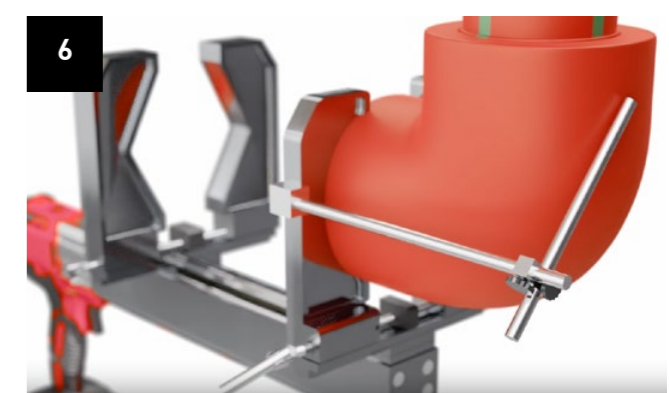
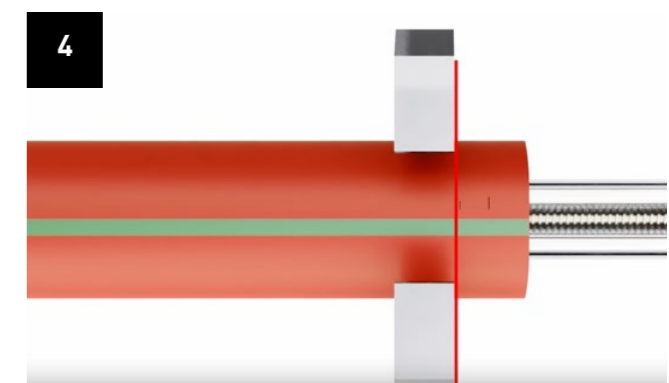
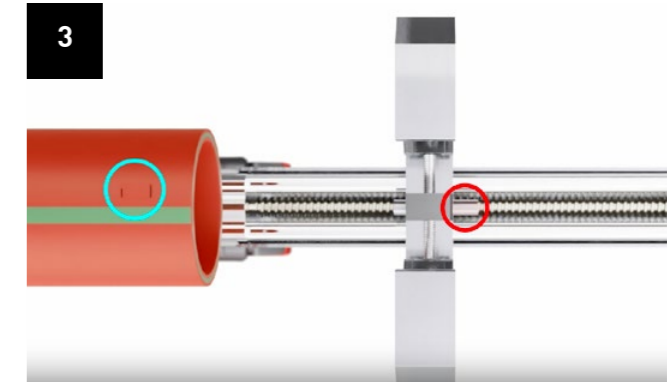
The pulling device is now placed on the moulded part or pipe to be moulding or pipe with the clamping jaws.

The arrows on the clamping jaws and the machine must be flush with each other. The clamping jaws are fixed in place using the clamping device (Fig. 3).

The pipe is aligned so that the rear marking is flush flush with the inside edge of the clamping jaw is flush with the inside edge of the clamping jaw. The front mark indicates the welding depth (Fig. 4).

Clamp the pipe and moulded part using the front set screws with the front set screws (Fig. 5)

Never clamp so tightly that deformations occur. The moulded part support can also be used to can be used to stabilise all moulded parts. The support is mounted on the clamping jaw for moulded parts (Fig. 6)



Fusion

Hold the welding machine between the pipe and the moulded part and move the machine carriage together in (Fig. 7 + 8). Pay attention to the welding depth.

In principle, the clamping jaws must be removed after pipe and moulded part into the welding tool tool by briefly moving the machine back (3-7mm) to relieve the pressure! The clamping jaws must always always be parallel to each other.

After the heating time has elapsed, move the machine carriage and remove the welding unit (Fig. 9).

Move the clamping jaws together again (Fig. 10) and again by briefly moving the machine back (3-7 mm) to relieve the clamping jaws.

ATTENTION:

When opening and closing the machine, do not overload the clutch must not be overloaded. The clamping jaws may only be released after the cooling time be released!

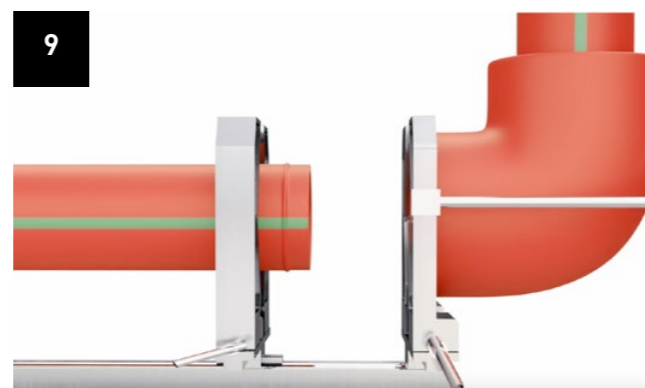
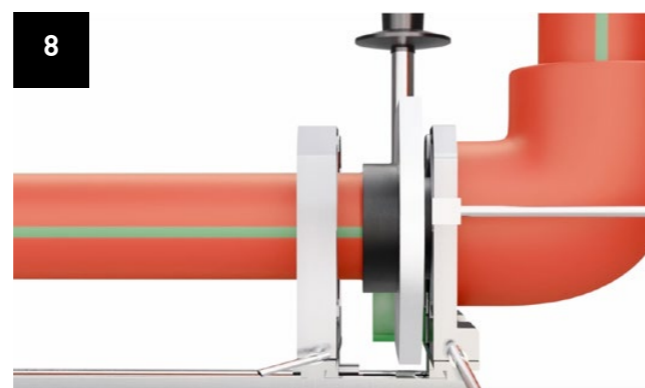
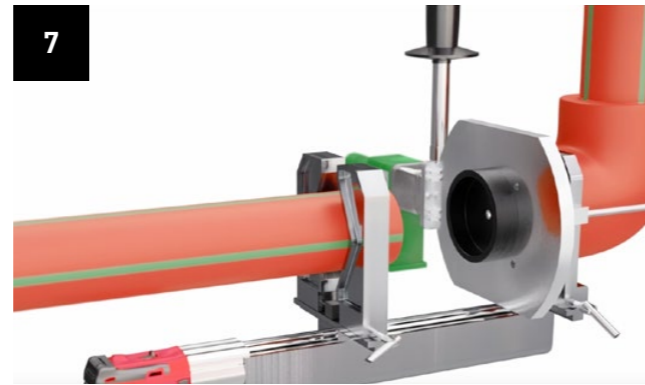
The pipe and moulded part are now fused together into one material unit.

The fusion is subject to the following data:

Pipe external-Ø	Welding depth	Heat-up time	Welding time	Cooling time
mm	mm	sec. DVS	sec	min
63	27.5	24	8	6
75	30.0	30	8	8
90	33.0	40	8	8
110	37.0	50	10	8
125	40.0	60	10	8

The General Guidelines for Heated Socket Welding acc. to DVS 2207 Part 11 apply.

We also offer a manual pulling device (see page 67).



FUSION

PART E: Welding machines __

Welding machine __

Scope of delivery:

- One wooden transport box for the welding machine
- aquatherm welding tools diameter 50, 63, 75, 90, 110, 125 mm
- One Allan key and tool change clamp
- One aquatherm thermocolour crayon
- One Installation manual
- One roll stand

The aquatherm welding machine was especially developed for stationary welding of pipe and fittings with an external diameter of 50 to 125 mm. This machine is equipped with a hand crank to facilitate a precise pre-assembly of complicated installation parts.

[▶ View video](#)



The fusion is subject to the following data:

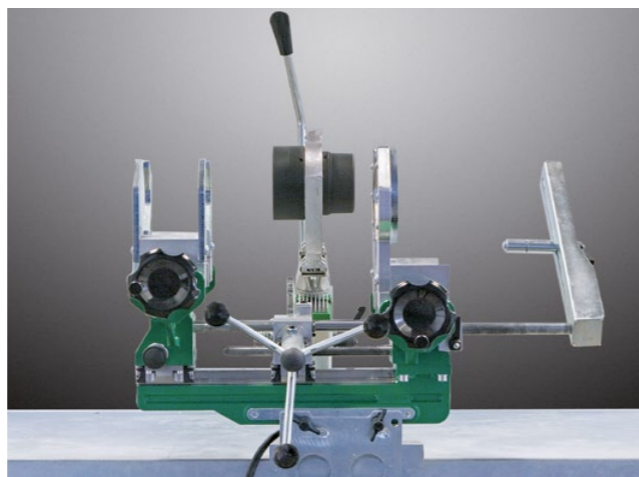
Pipe external-Ø	Welding depth	Heating time	Welding time	Cooling time
mm	mm	sec. DVS	sec	min
50	23.5	18	6	4
63	27.5	24	8	6
75	30.0	30	8	8
90	33.0	40	8	8
110	37.0	50	10	8
125	40.0	60	10	8

The General Guidelines for Heated Tool Socket Welding acc. to DVS 2207 Part 11 apply.

Welding machine Prisma-light __

With heating plate without tools – clamping fixture for fixing the prisma-light, e. g. at the work bench.

1. Check machine: temperature lamp blinks after reaching the welding temperature (260 °C), adjust clamping jaws 63–125 mm coarsely. Mark welding depth with the template at the pipe.
2. Fix the fitting against the clamping jaws.
3. Place the pipe loose in the opposite clamping jaws.
4. Position the welding device centrally to the pipe-fitting axis and remove it.
5. Lock the front calibration knob and drive up the slide as far as it will go.
6. In this position, push the pipe against the fitting and fix it with the clamping jaws.
7. Regulate the welding time according to the table on page 38 place the welding device and push the fitting and pipe slowly as far as it will go up to the marking.



8. The heating time starts when pipe and fitting are completely pushed on the tool. When heating time is complete, return the slide, remove the heating device quickly and join the pipe and fitting.

9. Consider cooling times from the table on page 38.

FUSION

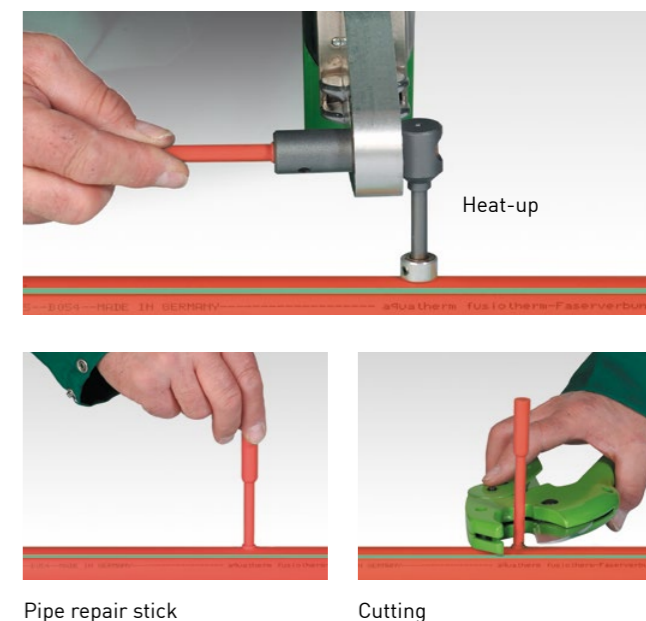
PART F: Repair __

Damaged pipes may be repaired – as already mentioned – by fusion welding (see part B).

In addition, the aquatherm red pipe system offers the possibility of repair by repair stick.

The suitable welding tool (Art. no. 9800050307 / 9800050311) and the repair stick (Art. no. 3090000012) are described from page 69.

The installation information is enclosed with the welding tool, but may also be ordered separately.



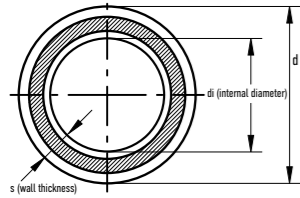
Pipe repair stick

Cutting



aquatherm red
Article list

Pipes, basic elements



aquatherm red SDR 7.4 MF HI SDR 7.4

Material: fusiolen® PP-R FS
Pipe series: 7.4
Colour: red/4 green stripes
Packing Unit: straight length 5.8 m

Art. no.	d [mm]	s [mm]	di [mm]	l/m	kg/m	DN	PU [m]
socket welding							
3012025008	25	3.5	18.0	0.254	0.249	15	116
3012032010	32	4.4	23.2	0.423	0.400	20	58
3012040012	40	5.5	29.0	0.660	0.621	25	58
3012050014	50	6.9	36.2	1.029	0.968	32	29
3012063016	63	8.6	45.8	1.647	1.521	40	17.4
3012075018	75	10.3	54.4	2.323	2.165	50	17.4
3012090020	90	12.3	65.4	3.358	3.101	65	11.6
3012110022	110	15.1	79.8	4.999	4.642	80	5.8
3012125024	125	17.1	90.8	6.472	5.974	90	5.8

Approvals as line and distribution pipes:

in suspended ceilings: 25 mm to 75 mm (DN15 - DN50)

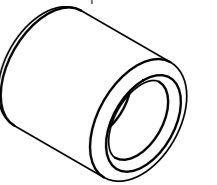
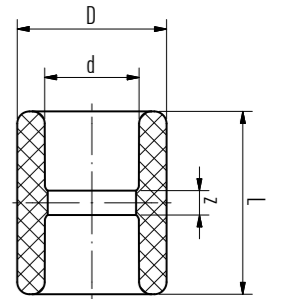
in concrete: 25 mm to 125 mm (DN15 - DN90)

as well as fittings in the corresponding dimensions.

Sockets

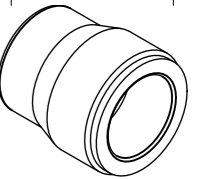
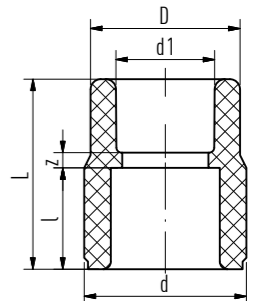
aquatherm red socket / B1 SDR 7.4

Art. no.	d	D	L	z	kg	PU
socket welding						
3040025020	25	34.0	35.0	3.0	0.014	10
3040032021	32	43.0	40.5	4.5	0.027	5
3040040022	40	52.0	47.5	6.5	0.044	5
3040050023	50	68.0	53.0	6.0	0.086	5
3040063024	63	84.0	60.5	5.5	0.145	1
3040075025	75	100.0	66.5	6.5	0.233	1
3040090026	90	120.0	72.5	6.5	0.353	1
3040110027	110	147.0	82.0	8.0	0.606	1
3040125028	125	167.0	92.0	12.0	0.819	1



aquatherm red reducer / B1 SDR 7.4

Art. no.	d	d1	l	D	L	z	kg	PU
socket welding								
3040032030	32	25.0	18	34.0	38.0	4.0	0.016	5
3040040031	40	32.0	20.5	43.0	50.0	11.5	0.033	5
3040050032	50	32.0	23.5	43.0	54.0	12.5	0.054	5
3040050033	50	40.0	23.5	52.0	53.0	9.0	0.059	5
3040063034	63	50.0	27.5	68.0	63.5	12.5	0.122	1
3040075035	75	50.0	30	68.0	63.0	9.5	0.143	1
3040075036	75	63.0	30	84.0	71.0	13.5	0.173	1
3040090037	90	63.0	33	84.0	78.0	17.5	0.232	1
3040090038	90	75.0	33	100.0	81.5	18.5	0.281	1
3040110039	110	63.0	37	84.0	86.0	21.5	0.363	1
3040110040	110	90.0	37	120.0	99.0	29.0	0.564	1
3040125041	125	90.0	40	120.0	99.0	26.0	0.831	1
3040125042	125	110.0	40	147.0	112.0	35.0	0.811	1

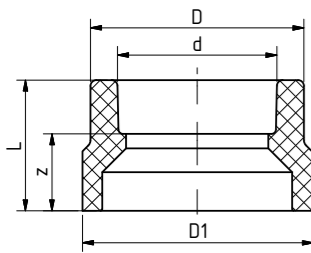


Legend table abbreviations (Units in mm unless otherwise specified)

d	diameter in mm	l/m	water content in litres/metre	SDR	standard dimension ratio (diameter/wall thickness ratio)
D	diameter in mm	kg/m	weight data in kg per metre		
s	wall thickness in mm	DN	diameter nominal		
di	internal diameter in mm	PU	packing unit in metre		



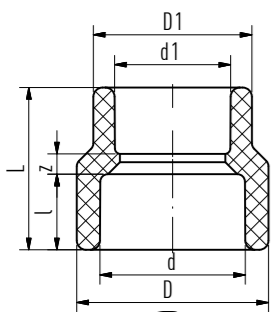
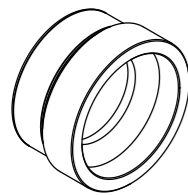
Sockets



aquatherm red reducer / B1

SDR 11

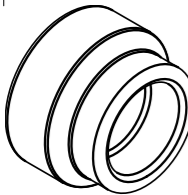
Art. no.	d	D	D1	L	z	kg	PU
butt welding							
3044160000	110	147	160	90	53	0.681	1
3044160001	125	167	160	90	50	0.729	1



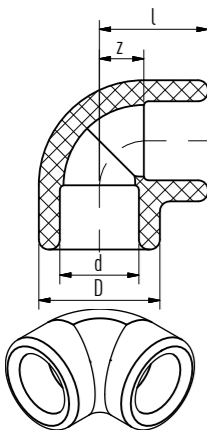
aquatherm red reducing socket / B1

SDR 7.4

Art. no.	d	d1	l	D	D1	L	z	kg	PU
socket welding									
3040063005	63	50.0	27.5	84.0	68	56.0	5.0	0.126	1
3040075006	75	63.0	30	100.0	84	62.5	5.0	0.191	1
3040090007	90	75.0	33	120.0	100	69.0	6.0	0.297	1



Elbow



aquatherm red elbow 90° / B1

SDR 7.4

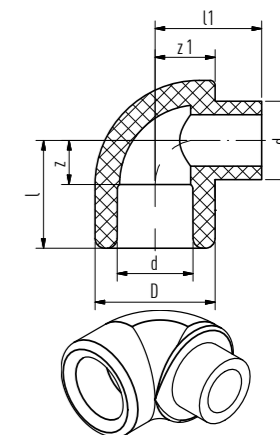
Art. no.	d	l	D	z	kg	PU
socket welding						
3080025001	25	29.5	34.0	13.5	0.023	10
3080032002	32	35	43.0	17.0	0.043	5
3080040003	40	41.5	52.0	21.0	0.071	5
3080050004	50	49.5	68.0	26.0	0.158	5
3080063005	63	60	84.0	32.5	0.276	1
3080075006	75	68.5	100.0	38.5	0.446	1
3080090007	90	79	120.0	46.0	0.798	1
3080110008	110	93	147.0	56.0	1.323	1
3080125009	125	116.5	167.0	76.5	2.026	1

Elbow

aquatherm red elbow 90° / B1 / female/male

SDR 7.4

Art. no.	d	l	l1	D	z	z1	kg	PU
socket welding								
3080032010	32	35	39	43.0	17.0	21.5	0.049	5
3080040011	40	41.5	45.5	52.0	21.0	26	0.081	5

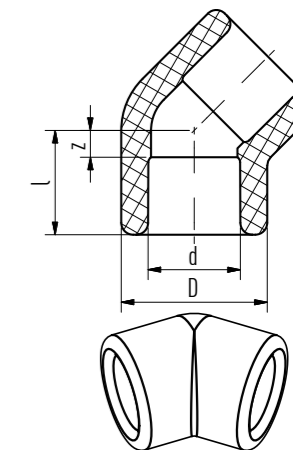


aquatherm red elbow 45° / B1

SDR 7.4

Art. no.	d	l	D	z	kg	PU
socket welding						
3080025020	25	22	34.0	6.0	0.019	10
3080032021	32	25.5	43.0	7.5	0.035	5
3080040022	40	30	52.0	9.5	0.057	5
3080050023	50	35	68.0	11.5	0.112	5
3080063024	63	41.5	84.0	14.0	0.233	1
3080075025	75	46.5	100.0	16.5	0.353	1
3080090026	90	52.5	120.0	19.5	0.571	1
3080110027	110	60.5	147.0	23.5	0.993	1
3080125028	125	67	167.0	27.0	1.281	1

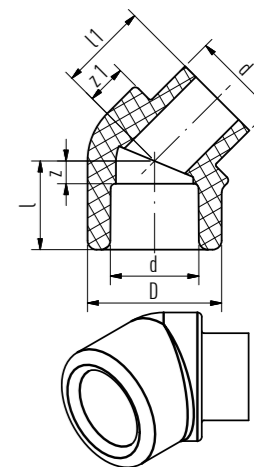
Note: Special bends in different degree dimensions on request



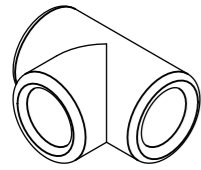
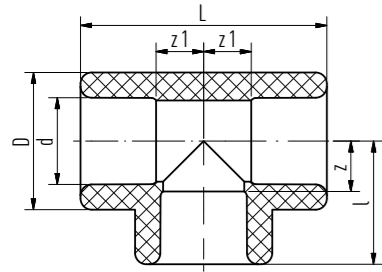
aquatherm red elbow 45° / B1 / female/male

SDR 7.4

Art. no.	d	l	l1	D	z	z1	kg	PU
socket welding								
3080032029	32	25.5	28.5	43.0	7.5	11.5	0.036	5
3080040030	40	30	30.5	52.0	9.5	13.5	0.059	5



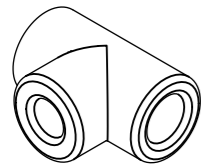
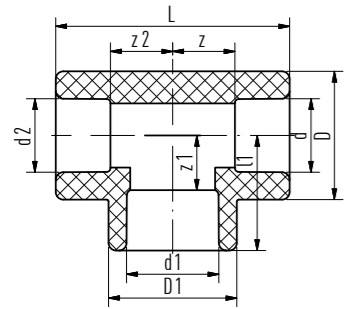
T-piece __



aquatherm red T-piece / B1

SDR 7.4

Art. no.	d	l	D	L	z	z1	kg	PU
socket welding								
3060025012	25	30.5	34.0	62.0	14.5	15	0.033	10
3060032013	32	33.5	43.0	70.0	15.5	17	0.053	5
3060040014	40	40.5	52.0	81.0	20.0	20	0.093	5
3060050004	50	49.5	68.0	99.0	26.0	26	0.200	5
3060063005	63	60	84.0	120.0	32.5	32.5	0.377	1
3060075006	75	68.5	100.0	137.0	38.5	38.5	0.537	1
3060090007	90	80	120.0	158.0	47.0	46	0.986	1
3060110008	110	93	147.0	186.0	56.0	56	1.632	1
3060125009	125	116.5	167.0	233.0	76.5	76.5	2.693	1



aquatherm red reducing T-piece / B1

SDR 7.4

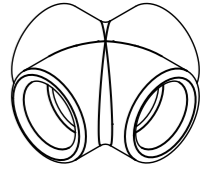
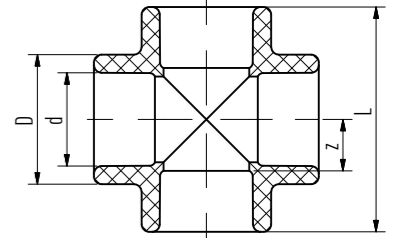
Art. no.	d	d1	d2	l1	D	D1	L	z	z1	z2	kg	PU
socket welding												
3060040010	40	32.0	40.0	40.5	52.0	52	84.0	21.5	22.5	21.5	0.106	5
3060050011	50	32.0	50.0	44.5	68.0	43	99.0	26.0	26.5	26.0	0.174	5
3060050012	50	40.0	50.0	49.5	68.0	68	99.0	26.0	29	26.0	0.221	5
3060063013	63	32.0	63.0	53.5	84.0	52	120.0	32.5	35.5	32.5	0.355	1
3060063014	63	40.0	63.0	53.5	84.0	52	120.0	32.5	33	32.5	0.341	1
3060063015	63	50.0	63.0	60	84.0	68	120.0	32.5	36.5	32.5	0.411	1
3060075016	75	40.0	75.0	59	100.0	52	137.0	38.5	38.5	38.5	0.494	1
3060075017	75	50.0	75.0	66	100.0	84	137.0	38.5	42.5	38.5	0.540	1
3060075018	75	63.0	75.0	66	100.0	84	137.0	38.5	38.5	38.5	0.507	1
3060090019	90	40.0	90.0	66.5	120.0	52	158.0	46.0	46	46.0	0.986	1
3060090020	90	50.0	90.0	69.5	120.0	68	158.0	46.0	46	46.0	0.976	1
3060090021	90	63.0	90.0	73.5	120.0	84	158.0	46.0	46	46.0	0.969	1
3060090022	90	75.0	90.0	76	120.0	100	158.0	46.0	46	46.0	0.997	1
3060110023	110	63.0	110.0	83.5	147.0	84	186.0	56.0	56	56.0	1.691	1
3060110024	110	75.0	110.0	86	147.0	100	186.0	56.0	56	56.0	1.634	1
3060110025	110	90.0	110.0	89	147.0	120	186.0	56.0	56	56.0	1.569	1
3060125026	125	75.0	125.0	106.5	167.0	100	233.0	76.5	76.5	76.5	2.475	1
3060125027	125	90.0	125.0	109.5	167.0	120	233.0	76.5	76.5	76.5	2.542	1
3060125028	125	110.0	125.0	113.5	167.0	147	233.0	76.5	76.5	76.5	2.606	1

Crosspiece __

aquatherm red crosspiece / B1

SDR 7.4

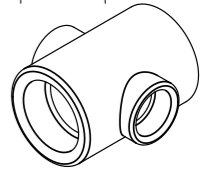
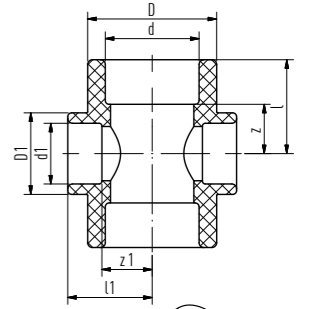
Art. no.	d	D	L	z	kg	PU
socket welding						
3040032000	32	43.0	70.0	17.0	0.064	5
3040040001	40	52.0	83.0	21.0	0.101	5



aquatherm red reducing crosspiece / B1

SDR 7.4

Art. no.	d	d1	l	l1	D	D1	z	z1	kg	PU
socket welding										
3040050010	50	32.0	49.5	44.5	68.0	43	26.0	26.5	0.180	1
3040063011	63	32.0	60	53.5	84.0	52	32.5	35.5	0.350	1
3040063012	63	40.0	60	53.5	84.0	52	32.5	33	0.328	1
3040075013	75	32.0	68.5	59	100.0	52	38.5	41	0.509	1
3040075014	75	40.0	68.5	59	100.0	52	38.5	38.5	0.499	1
3040075015	75	50.0	68.5	66	100.0	68	38.5	42.5	0.528	1
3040090016	90	50.0	68.5	75	120.0	68	35.5	51.5	0.762	1

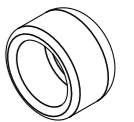
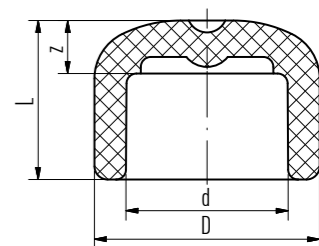


Endcaps __

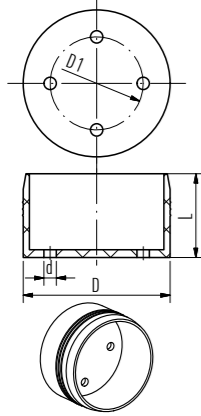
aquatherm red end cap / B1

SDR 7.4

Art. no.	d	D	L	z	kg	PU
socket welding						
3020025008	25	34.0	24.0	8.0	0.011	10
3020032010	32	43.0	29.0	11.0	0.044	5
3020040012	40	52.0	38.0	17.5	0.042	5
3020050014	50	68.0	44.5	21.0	0.082	5
3020063016	63	84.0	52.0	24.5	0.153	1
3020075018	75	100.0	58.5	28.5	0.245	1
3020090020	90	120.0	67.5	34.5	0.377	1
3020110022	110	147.0	65.0	28.0	0.648	1
3020125024	125	167.0	82.0	42.0	0.872	1



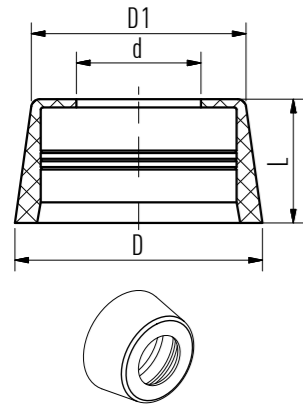
Sprinkler accessories __



aquatherm red base part for sprinkler outlet

for visible sprinkler

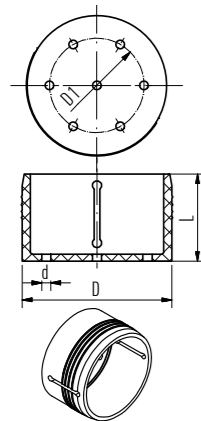
Art. no.	d	D	D1	L	kg	PU
3090000001	4	47.4	30	27.0	0.013	25



aquatherm red upper part for sprinkler outlet

for visible sprinkler

Art. no.	Dimension	d	D	D1	L	kg	PU
3090000002	1/2"	23.2	60.0	51.4	30.5	0.022	25
3090000003	3/4"	30.2	60.0	51.6	30.0	0.022	25
3090000004	1"	35.2	60.0	51.6	30.0	0.021	25



aquatherm red base part for sprinkler outlet

for covered sprinkler

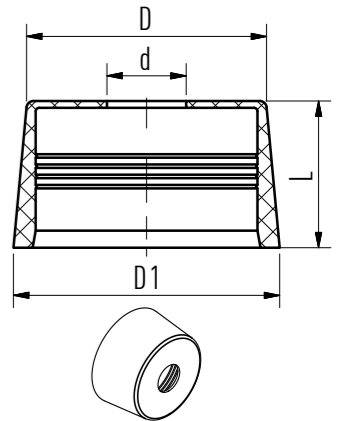
Art. no.	d	D	D1	L	kg	PU
3090000005	4	65.0	44	38.0	0.034	25

Sprinkler accessories __

aquatherm red upper part for sprinkler outlet

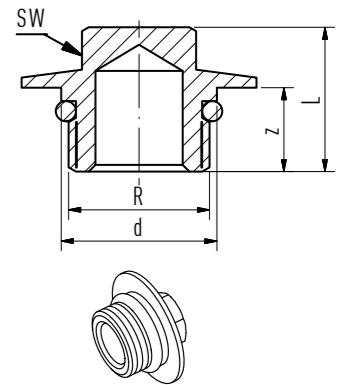
for covered sprinkler

Art. no.	Dimension	d	D	D1	L	kg	PU
3090000006	1/2"	23.2	70.0	78	43.0	0.057	25
3090000007	3/4"	30.2	70.0	78	43.0	0.057	25
3090000008	1"	35.2	70.0	78	43.0	0.056	25



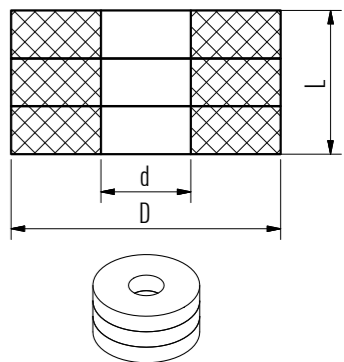
aquatherm red plug for sprinkler outlet

Art. no.	R	d	L	z	SW	kg	PU
3050000010	1/2"	23	21.5	12.5	15	0.043	25
3050000011	3/4"	30	23.0	12.5	17	0.058	25
3050000013	1"	35	24.0	13.0	17	0.076	25



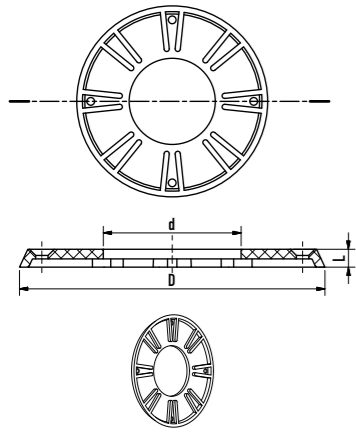
aquatherm red temporary plug for plaster works

Art. no.	d	D	L	kg	PU	
9704114178	for Art. no. 3090000002, 03, 04	20	60.0	32.0	0.003	50
9704114179	for Art. no. 3090000006, 07, 08	20	75.5	42.0	0.005	50

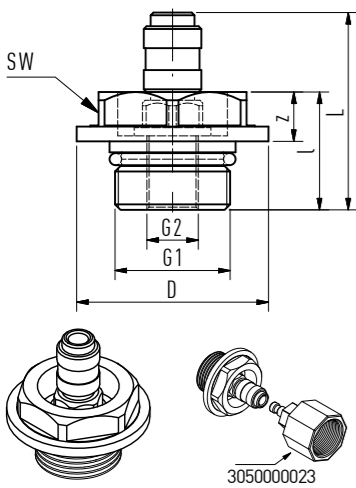


Sprinkler accessories

aquatherm red sprinkler outlet

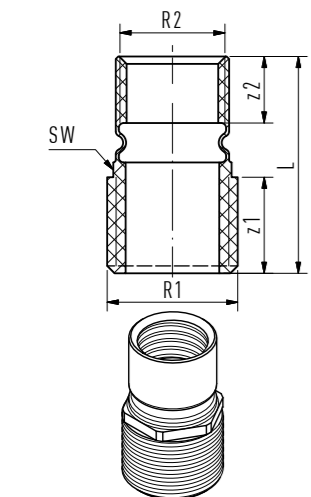


Art. no.	R	d	D	L	kg	PU
309000009	1 1/4"	44.1	100.1	6.5	0.028	10
309000010	1 1/2"	50.1	111.1	6.5	0.034	10
309000011	2"	61.1	126.1	6.5	0.043	10



aquatherm red plug for pressure test

Art. no.	l	D	L	z	G1	G2	SW	kg	PU
305000020	21.5	35.0	36.0	9.0	1/2"	1/8"	27	0.072	10
305000021	21.5	35.0	36.0	9.0	3/4"	1/8"	27	0.093	10
305000022	21.5	40.0	36.0	8.5	1"	1/8"	27	0.126	10
305000023	coupling plug 1/2"							0.040	1



aquatherm red compensating joint

Without VdS-approval

Art. no.	L	z1	z2	R1	R2	SW	kg	PU
9604114231	44.0	17.5	15.5	3/4"	3/8"	24	0.054	10
9604114233	44.0	19.5	13.5	3/4"	1/2"	24	0.043	10
9604114235	45.0	17	17.0	1"	1"	36	0.067	10
9604114237	44.0	19.5	13.5	1"	1/2"	30	0.052	10

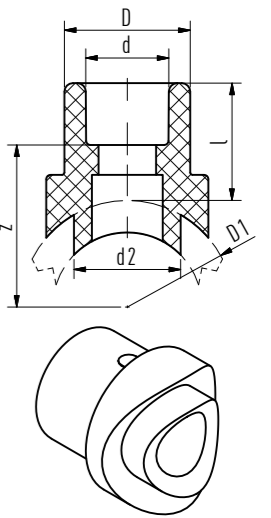
Weld-in saddle

aquatherm red weld-in saddle / B1

SDR 7.4. With weld-on surface and weld-in socket to be fused with the inner wall of the pipe

Art. no.	D1	d	d2	l	D	z	kg	PU
socket welding								
3030063001	63	32	32.0	30	43.0	43.5	0.028	5
3030075002	75	32	32.0	30	43.0	49.5	0.028	5
3030075003	75	40	40.0	34	52.0	51.0	0.049	5
3030090004	90	32	32.0	30	43.0	57.0	0.029	5
3030090005	90	40	40.0	34	52.0	58.5	0.048	5
3030110006	110	32	32.0	30	43.0	67.0	0.030	5
3030110007	110	40	40.0	34	52.0	68.5	0.050	5
3030110008	110	50	50.0	34	68.0	65.5	0.030	5
3030125009	125	32	32.0	30	43.0	74.5	0.029	5
3030125010	125	40	40.0	34	52.0	76.0	0.050	5
3030125011	125	50	50.0	34	68.0	73.0	0.030	5
3030125012	125	63	63.0	38	84.0	73.0	0.154	5

aquatherm red weld-in saddle tools Art. no. 9800050620, 9800050624, 9800050625, 9800050628, 9800050629, 9800050632, 9800050634, 9800050635, 9800050638, 9800050640, 9800050642, 9800050644 (see page 69)
aquatherm drill Art. no. 9800050940-9800050948 (see page 70)

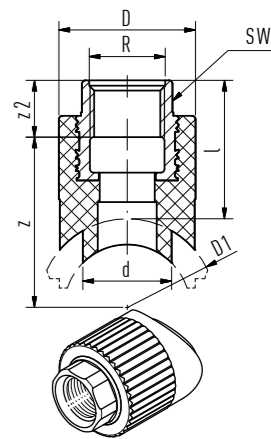


aquatherm red weld-in saddle with female thread / B1

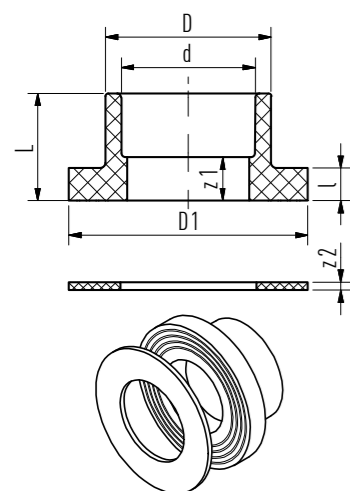
SDR 7.4. With female thread and hexagon socket, with weld-in weld-on surface and weld-in socket to be fused with the inner wall of the pipe

Art. no.	D1	d	l	D	z	z2	R	SW	kg	PU
one side socket welding										
3030040021	40	25	39	38.5	43.0	16.0	1/2"	24	0.088	5
3030050022	50	25	39	38.5	48.0	16.0	1/2"	24	0.090	5
3030063022	63	25	39	38.5	54.4	16	1/2"	24	0.089	5
3030075004	75	25	39	38.5	60.5	16	1/2"	24	0.097	5
3030075023 *	75	32	43	60.0	58.5	22.0	1"	39	0.221	5
3030090024 *	90	32	43	60.0	66.0	22.0	1"	39	0.222	5
3030110025 *	110	32	43	60.0	76.0	22.0	1"	39	0.088	5
3030125026 *	125	32	43	60.0	93.5	22.0	1"	39	0.091	5

aquatherm red tools for the fusion of Art. no. 9800050614, 9800050616, 9800050619, 9800050623, 9800050624, 9800050628, 9800050632, 9800050638 (see page 69)
aquatherm drill Art. no. 9800050940-9800050942 (see page 70)
*suitable for the connection to sprinkler outlets



Flange adapter __

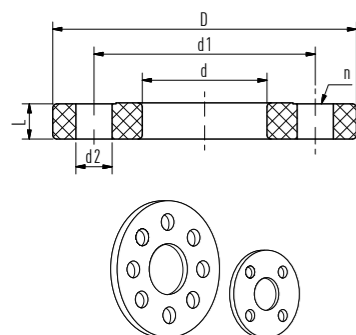


aquatherm red weldable flange adapter / B1

SDR 7.4. With joint ring

Art. no.	d	l	D	D1	L	z1	z2	kg	PU
one side socket welding									
3050032001	32	10	41.0	68	34.0	16	3.0	0.053	1
3050040002	40	11	50.0	78	35.5	15	3.0	0.071	1
3050050003	50	12	61.0	88	39.5	17	3.0	0.095	1
3050063004	63	14	76.0	102	43.5	16	3.0	0.130	1
3050075005	75	16	90.0	122	46.0	16	3.0	0.191	1
3050090006	90	17	108.0	138	50.0	17	3.0	0.258	1
3050110007	110	18.5	131.0	158	55.5	18.5	3.0	0.329	1
3050125008	125	20	165.0	188	63.0	23	3.0	0.724	1

aquatherm red steel flange



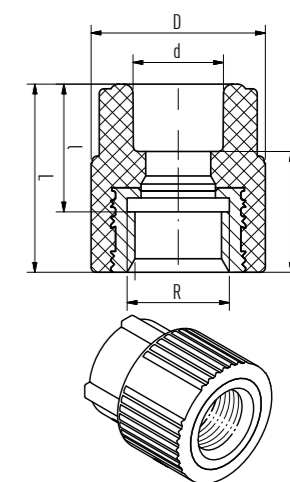
Art. no.	Dimension	d	d1	d2	D	L	n	kg	PU
9604114200	32	42	85.0	14.0	115.0	16.0	4	1.046	1
9604114201	40	51	100.0	18.0	140.0	16.0	4	1.589	1
9604114202	50	62	110.0	18.0	150.0	16.0	4	1.675	1
9604114206	63	78	125.0	18.0	165.0	16.0	4	2.016	1
9604114207	75	92	145.0	18.0	185.0	16.0	4	2.437	1
9604114208	90	110	160.0	18.0	200.0	18.0	8	2.699	1
9604114212	110	133	180.0	18.0	220.0	18.0	8	3.084	1
9604114213	125	167	210.0	18.0	250.0	18.0	8	3.654	1

Transition pieces __

aquatherm red transition piece / B1, round

With female thread. For the connection to sprinkler outlets

Art. no.	d	l	D	L	z	R	kg	PU
one side socket welding								
3070025020	25	29.5	38.5	42.5	26.5	1/2"	0.065	10
3070025021	25	27.5	43.5	40.5	24.5	3/4"	0.087	10
3070032022	32	30.5	43.5	43.5	25.5	3/4"	0.092	5
3070032023	32	30	37.5	43.0	25.0	1/2"	0.076	5
3070040024	40	32.5	37.5	45.5	25.0	1/2"	0.078	5
3070040025	40	33	50.0	46.0	25.5	3/4"	0.105	5

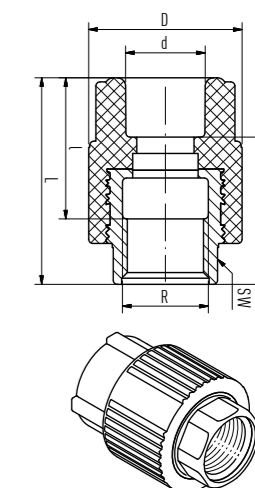


aquatherm red transition piece / B1, hexagon

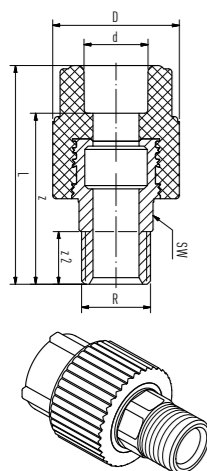
With female thread and hexagon

Art. no.	d	l	D	L	z	R	SW	kg	PU
one side socket welding									
3070032026	32	32	43.5	53.0	35.0	3/4"	31	0.104	5
3070032027 *	32	37.5	60.0	59.5	41.5	1"	39	0.239	5
3070040028 *	40	40	60.0	62.0	41.5	1"	39	0.227	5
3070040029	40	40	74.0	63.0	42.5	1 1/4"	50	0.385	5
3070050030	50	43	74.0	66.0	42.5	1 1/4"	50	0.404	5
3070050031	50	45	85.5	67.0	43.5	1 1/2"	55	0.445	5
3070063032	63	51.5	84.0	73.5	46.0	1 1/2"	55	0.479	1
3070063033	63	50	101.0	76.0	49.5	2"	67	0.662	1
3070075034	75	51	100.0	77.0	47.0	2"	67	0.671	1
3070032035	32	37	37.5	53.0	35.0	1/2"	24	0.091	5
3070040036	40	38	40.0	54.0	33.5	1/2"	24	0.094	5

* 1" thread is suitable for the connection to sprinkler outlets



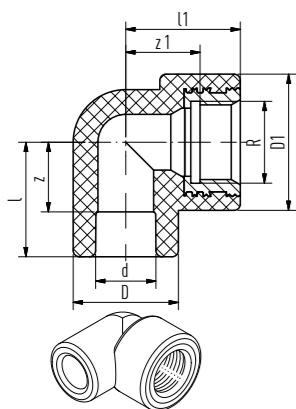
Transition pieces __



aquatherm red transition piece / B1, hexagon/octagon

with male thread and hexagonal spanner flat or *octagonal spanner flat

Art. no.	d	D	L	z	z2	R	SW	kg	PU
one side socket welding									
3070032037	32	38.5	69.5	51.5	17.0	3/4"	24	0.135	5
3070032038	32	53.0	78.5	60.5	20.0	1"	32	0.244	5
3070032039	32	68.0	81.0	63.0	21.0	1 1/4"	41	0.324	5
3070040040	40	52.0	81.0	60.5	20.0	1"	32	0.251	5
3070040041	40	68.0	84.5	64.0	21.0	1 1/4"	41	0.362	5
3070050042	50	68.0	85.5	62.0	21.0	1 1/4"	41	0.389	5
3070050043	50	74.0	88.5	65.0	22.0	1 1/2"	46	0.480	5
3070063044	63	72.5	94.5	67.0	22.0	1 1/2"	46	0.523	1
3070063045	63	84.0	102.5	75.0	23.5	2"	50	0.708	1
3070075046	75	84.0	102.0	72.0	23.5	2"	50	0.753	1
3070075047	75	100.0	105.0	75.0	26.7	2 1/2"	65	1.024	1
3070090048 *	90	120.0	121.0	88.0	30.0	3"	85	1.488	1
3070110049 *	110	147.0	148.0	111.0	39.0	4"	105	2.816	1



aquatherm red transition elbow 90° / B1

with female thread

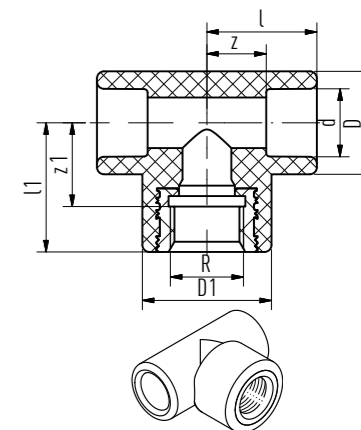
Art. no.	d	l	l1	D	D1	z	z1	R	kg	PU
one side socket welding										
3070032001	32	35	37	43.0	37	17.0	24	1/2"	0.088	10
3070032003	32	27.5	51	43.0	44	9.5	38	3/4"	0.112	5
3070032004	32	34	66.5	43.0	60.5	16.0	44.5	1"	0.265	5
3070040004	40	41.75	40	52.0	37	21.3	27	1/2"	0.116	5
3070040005	40	41.5	56	52.0	60	21.0	34	1"	0.265	5

Transition pieces __

aquatherm red threaded branch tee / B1

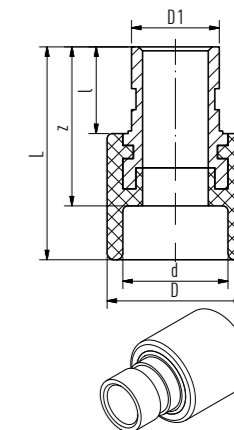
with female thread

Art. no.	d	l	l1	D	D1	z	z1	R	kg	PU
double sided socket welding										
3060025030	25	34.5	38	34.0	37	18.5	25	1/2"	0.088	10
3060032031	32	35	37	43.0	37	17.0	24	1/2"	0.113	5
3060032032	32	27.5	51	43.0	44	9.5	38	3/4"	0.118	5
3060032033	32	31.5	67	43.0	60	13.5	45	1"	0.274	5
3060040034	40	42	40	52.0	37	21.5	27	1/2"	0.113	5
3060040035	40	40.5	40.5	52.0	52	20.0	27.5	3/4"	0.157	5
3060040036	40	41.5	56	52.0	60	21.0	34	1"	0.279	5
3060050037	50	49.5	63.5	68.0	68.3	26.0	41.5	1"	0.387	5
3060050038	50	49.5	66.5	68.0	68	26.0	47.5	1 1/4"	0.478	5
3060050040	50	49.5	44.5	68.0	43	26.0	31.5	1/2"	0.237	5
3060050041	50	49.5	44.5	68.0	43	26.0	31.5	3/4"	0.243	5

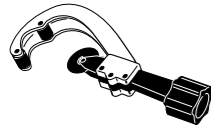


aquatherm red transition piece for groove connection / B1

Art. no.	d	l	D	D1	L	z	kg	PU
one side socket welding								
3070040010	40	33	52.0	33.5	81.0	60.5	0.239	1
3070050011	50	36	68.0	42.20	85.5	62.0	0.397	1
3070063012	63	39	84.0	48.25	97.5	70.0	0.568	1
3070075013	75	39	100.0	60.3	97.0	67.0	0.853	1
3070090014	90	39	120.0	88.9	110.0	77.0	1.285	1
3070110015	110	40.5	147.0	114.3	119.5	82.5	2.137	1
3070125016	125	75	167.0	140	170.0	130.0	5.046	1

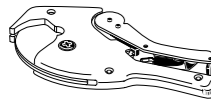


Tools



aquatherm pipe cutter

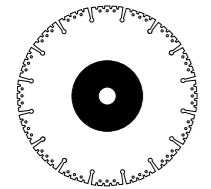
Art. no.	Dimension	PU
9800050102	for pipes ø 16 - 40 mm	1
9800050105	for pipes ø 50 - 125 mm	1
9800050106	for pipes ø 110 - 200 mm	1



aquatherm pipe cutter

Art. no.	Dimension	PU
9800050104	for pipes ø 16 - 40 mm	1

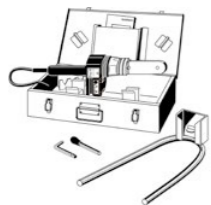
Important: Do not cut the aquatherm red pipes with customary hack saws. aquatherm red pipes can be cut with customary saws equipped with saw blades suitable for plastic.



aquatherm cutting disc for plastic

Art. no.	Dimension	Borehole	PU
9800050107	ø 125 mm	22.2 mm	1
9800050109	ø 230 mm	22.2 mm	1

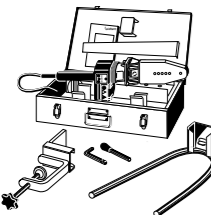
Application: for each angle grinder
Design: diamond galvanized cutting disc



aquatherm manual welding device (500 W)

Art. no.	Dimension	PU
9800050336	for pipes ø 16 - 32 mm	1

With base and case for tools



aquatherm manual welding device (800 W)

Art. no.	Dimension	PU
9800050336	for pipes ø 16 - 63 mm	1

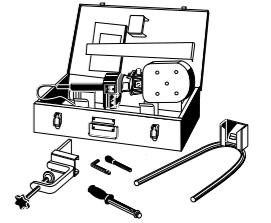
With base and case for tools

Tools

aquatherm manual welding device (1400 W)

Art. no.	Dimension	PU
9800050341	for pipes ø 50 - 125 mm	1

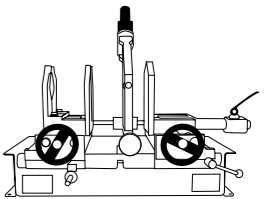
With base and case for tools



aquatherm welding machine (1400 W)

Art. no.	Dimension	PU
9800050148	for pipes ø 50 - 125 mm - 230 V	1

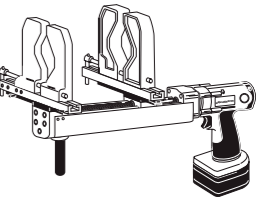
incl. welding tools 50-125 mm, roll stand and wooden transport case



aquatherm electric welding jig

Art. no.	Dimension	PU
9800050161	for pipes ø 63 - 125 mm	1

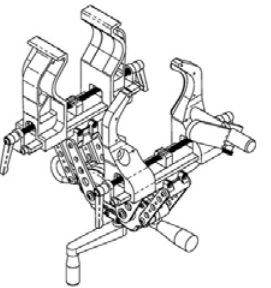
incl. spare battery, charging station and metal case



aquatherm manual welding jig 125 mm

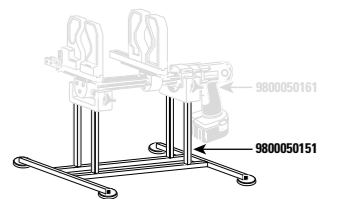
Art. no.	Dimension	PU
9800000002	for pipes ø 125 mm	1

incl. case



aquatherm base for Art. no. 9800050161

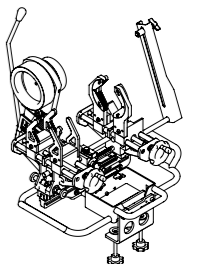
Art. no.	Dimension	PU
9800050151		1



aquatherm welding machine (1400 W) Light

Art. no.	Dimension	PU
9800050145	for pipes ø 63 - 125 mm	1

incl. aquatherm manual welding device (1400 W) and wooden transport case



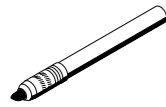
Tools __



aquatherm temperature measuring device

Art. no.	Dimension	PU
9800050188		1

to check the correct welding temperature



aquatherm thermocolour pencil

Art. no.	Dimension	PU
9800050190		1

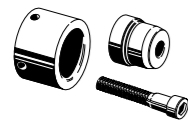
to check the correct welding temperature



aquatherm cleaning wipes

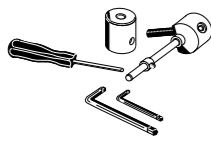
Art. no.	Dimension	PU
9800050193	box/100 wipes	1

for electrofusion sockets



aquatherm welding tool

Art. no.	Dimension [mm]	PU
9800050210	25	1
9800050212	32	1
9800050214	40	1
9800050216	50	1
9800050218	63	1
9800050220	75	1
9800050222	90	1
9800050224	110	1
9800050226	125	1



aquatherm repair kit

Art. no.	Dimension [mm]	PU
9800050307	7 mm	1
9800050311	11 mm	1

to close pipe holes up to 10 mm (pipe repair stick Art. no. 3090000012)

Tools __

aquatherm repair stick

Art. no.	Dimension [mm]	PU
3090000012	7/11	10

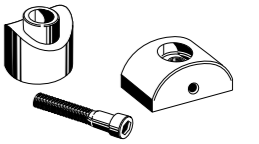
Material: fusiolen® PP-R FS to close pipe holes up to 10 mm.
Tool: aquatherm repair kit (Art. no. 9800050307 + 9800050311).



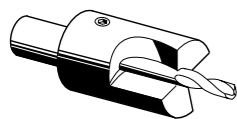
aquatherm saddle welding tool

for welding saddles of Art. no. 3030063001-3030125012 & 3030040021-3030125026

Art. no.	Dimension	PU
9800050614	40x20/25mm	1
9800050616	50x20/25mm	1
9800050619	63x20/25mm	1
9800050620	63x32mm	1
9800050623	75x20/25mm	1
9800050624	75x32mm	1
9800050625	75x40mm	1
9800050627	90x20/25mm	1
9800050628	90x32mm	1
9800050629	90x40mm	1
9800050631	110x20/25mm	1
9800050632	110x32mm	1
9800050634	110x40mm	1
9800050635	110x50mm	1
9800050636	125x20/25mm	1
9800050638	125x32mm	1
9800050640	125x40mm	1
9800050642	125x50mm	1
9800050644	125x63mm	1



Tools __

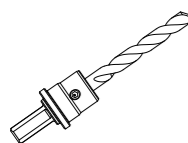


aquatherm Drill

for installation of weld-in saddles

Art. no.	Dimension	PU
9800050940	20 & 25 mm (for pipes 40 - 160 mm)	1
9800050942	32 mm	1
9800050944	40 mm	1
9800050946*	50 mm	1
9800050948*	63 mm	1
9800050987*	75 mm	1
9800050988*	90 mm	1

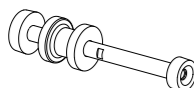
* may only be used in fixed drilling machines



aquatherm quick change adapter 75 - 90 mm

für Sprinklerdose Art- Nr. 3090000002-04

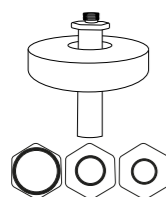
Art. no.	Dimension	PU
9800050973	for Art. no. 9800050987 - 9800050988	1



aquatherm extraction tool

for sprinkler outlet Art. no. 3090000002-04

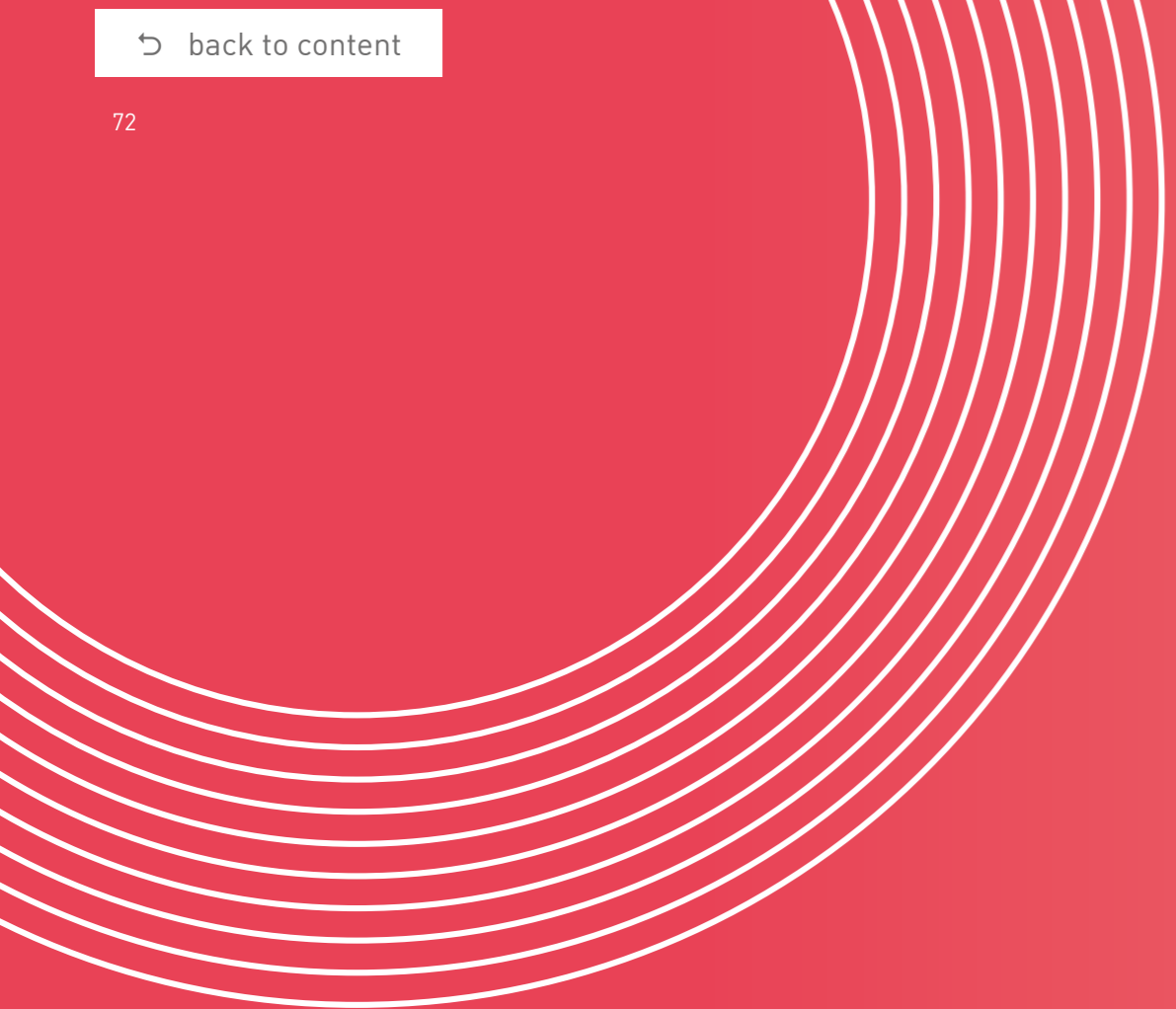
Art. no.	PU
9800050290	1



aquatherm adjusting tool

for compensating joint with adapter 3/8" male, 1/2" male and 1" male

Art. no.	PU
9800050291	1



aquatherm red
Laying in the concrete

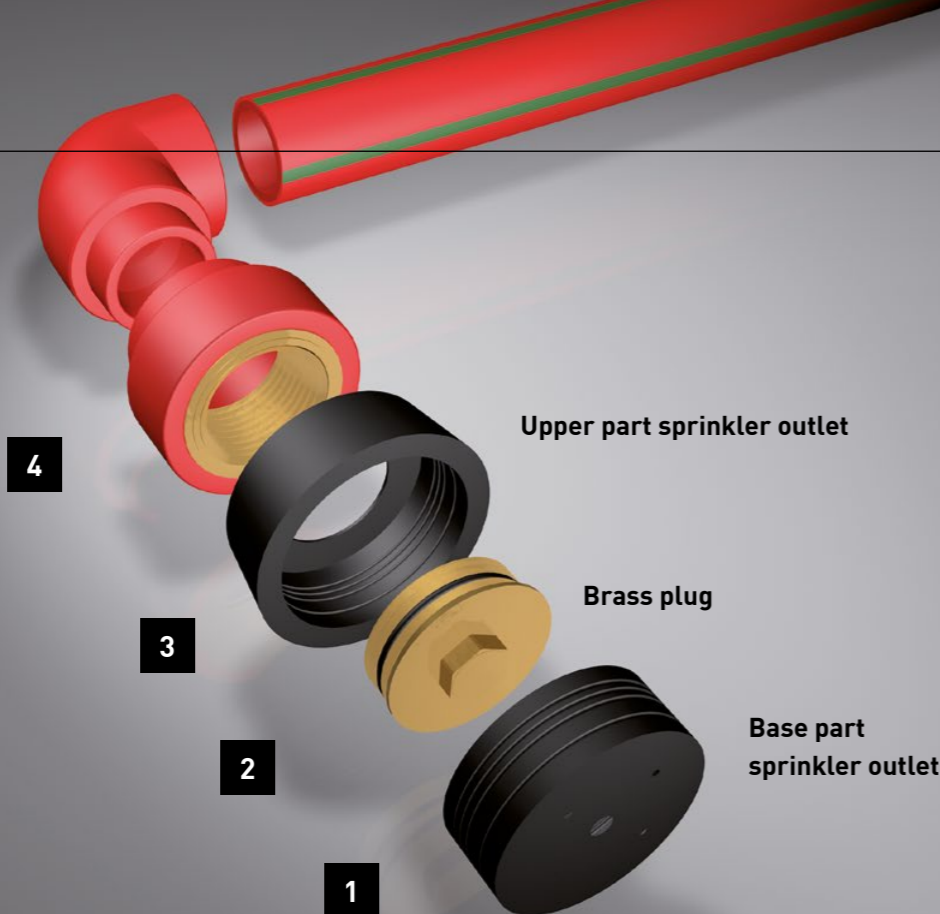


Illustration 1



Illustration 2

LAYING IN THE CONCRETE

Laying of aquatherm red in the concrete

Description

The encasing of aquatherm red pipes and polypropylene fittings offers the builder a space-saving, invisible and corrosion-resistant pipework system for sprinkler applications.

PART 1:

Connecting of pipe work to the aquatherm red sprinkler outlet

The connection is described in picture 1 as follows: The base part of the sprinkler outlet (1) is screwed with 5 screws on the shuttering.

Part 2, 3 and 4 are bolted together and plugged on part 1, so that part 3 is flush with the casing.

The O-ring on part 2 (plug) must always be clean and greased with mounting grease. After the repeated use the O-ring should be replaced.

This applies to the item-no.:

- 3050000010
- 3050000011
- 3050000013
- 3050000015
- 3050000016
- 3050000017
- 3050000020
- 3050000021
- 3050000022

Detailed information regarding the different dimensions of the sprinkler outlet please take from tables on pages 58 and 58!

Colour of plastic sleeve may differ.



The aquatherm red sprinkler connection is now ready (illustration 2).

After removing the panelling (after pouring the concrete), pull the lower part (part 1) of the sprinkler of the sprinkler connection box from the upper part (part 3) of the sprinkler connection box.

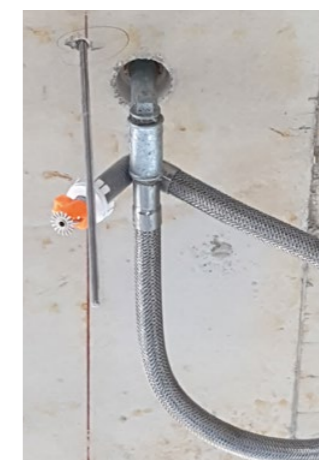
Remove the brass plug (part 2) from the aquatherm red connection piece (part 4). The upper part of the sprinkler connection box (part 3) must be the combination extraction tool (available on request) from the concrete. We recommend the aquatherm red combi extraction tool art. no. 9800050290 for the sprinkler connection boxes art. no. 3090000002-3090000008.

Effortless connection of the sprinkler (illustration 3) is now possible. The distance required according to CEA 4001 from the sprinkler disc to the finished ceiling can be from the sprinkler connection thread to the aquatherm red connection piece.

At the threaded connections 3/4", 1", 1 1/4", 1 1/2" and 2" in a concrete ceiling (illustration 3), in addition to sprinklers, angled connections with a steel pipe or with a flexible hose.

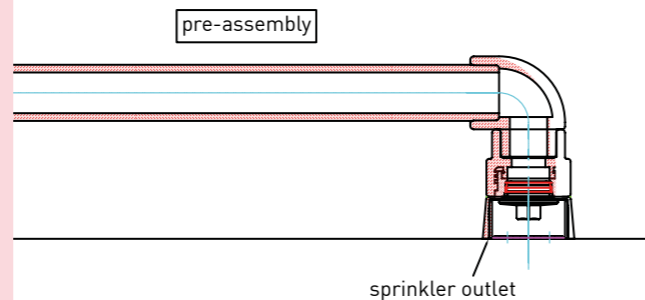


Illustration 3 finished sprinkler connection in the concrete ceiling



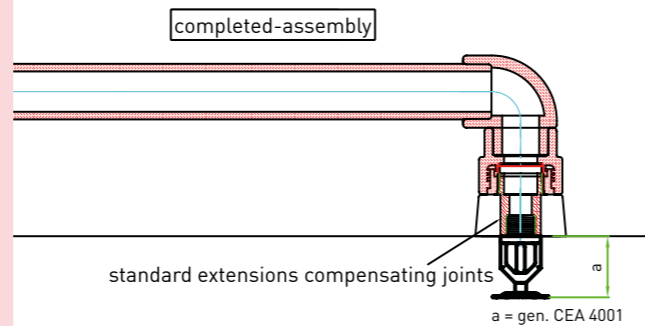
Laying of aquatherm red in the concrete __

Sprinkler outlet consists of the base part, upper part and plug.



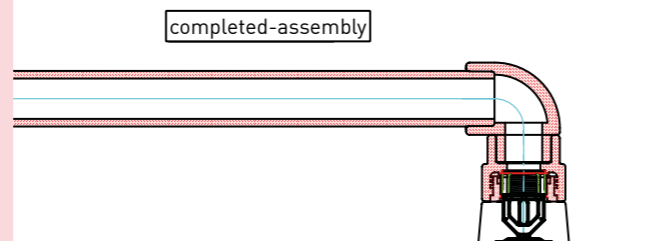
Visible sprinkler

For the distance from the deflector to the ceiling, refer to the CEA-4001. You will find compensating joints on page 60.

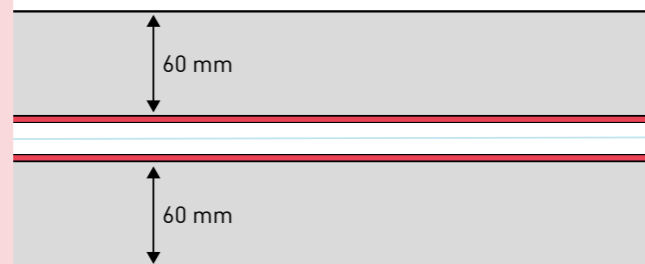


Covered sprinkler

For further information on the sprinkler outlets please see the tables on pages 58 and 58.



It has to be ensured that the aquatherm red is covered above and below by a minimum 60 mm layer concrete layer.



aquatherm red **compensating joint and adjusting tool** __

Pipe system made of polypropylene
for sprinklers

Compensation joint for use with „aquatherm red“, pipe system made of plastic, VdS approval number: G4050042

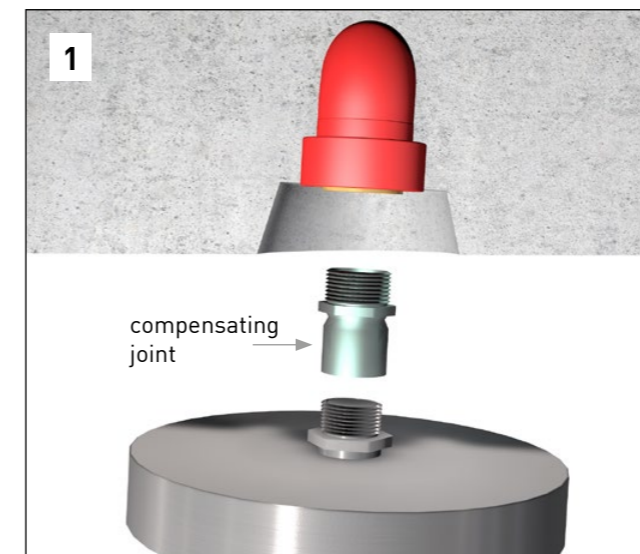
The specifications of the technical catalogue „aquatherm red“ and the VdS CEA 4001 (Guidelines for sprinkler systems – planning and installation) are valid.

Application:

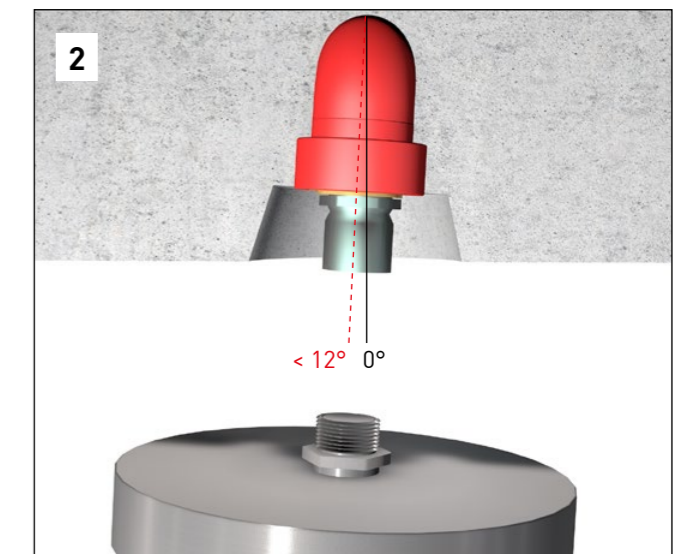
Correction of non-aligned sprinkler connections in concrete ceilings, maximum correction angle 12° and for compensation of the connection thread to the sprinkler thread (maximum 3 cm) in concrete ceilings, maximum operating pressure 18 bar.

Important instructions:

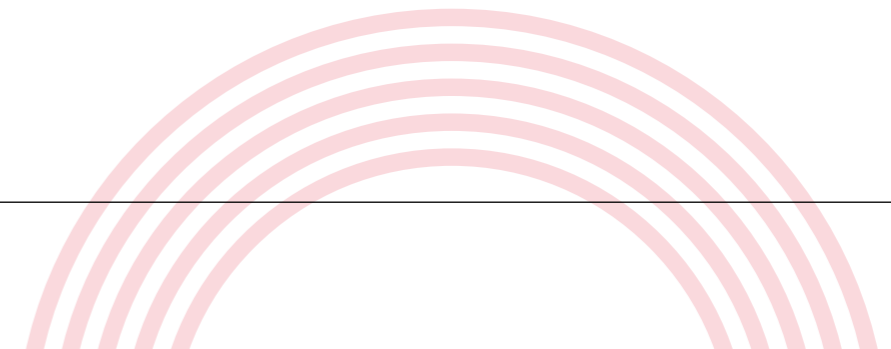
- The compensating joint may only be bent once – multiple reverse bending is not permitted
- Maximum tightening torque for sprinkler = 29 Nm
- Only for the direct connection of the sprinkler



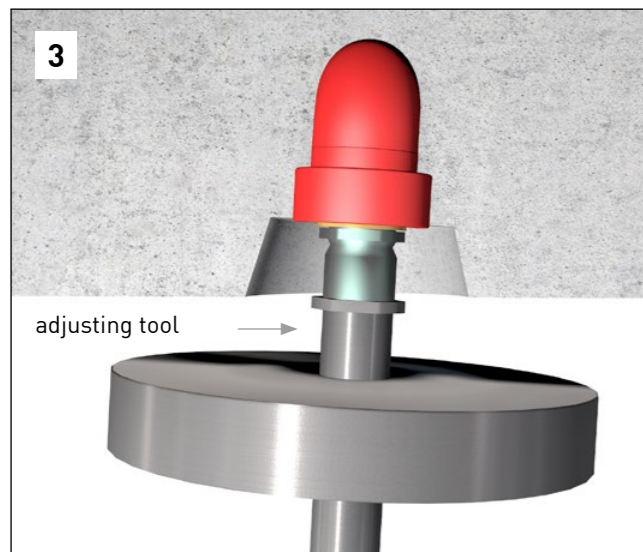
1) If the sprinkler connection protrudes obliquely from the concrete surface, it is possible to align this with the balancing connection. The balancing connection is installed with the provided hexagon in the sprinkler connection thread. A common sealing method for the preparation of waterproof threaded connections is to be used.



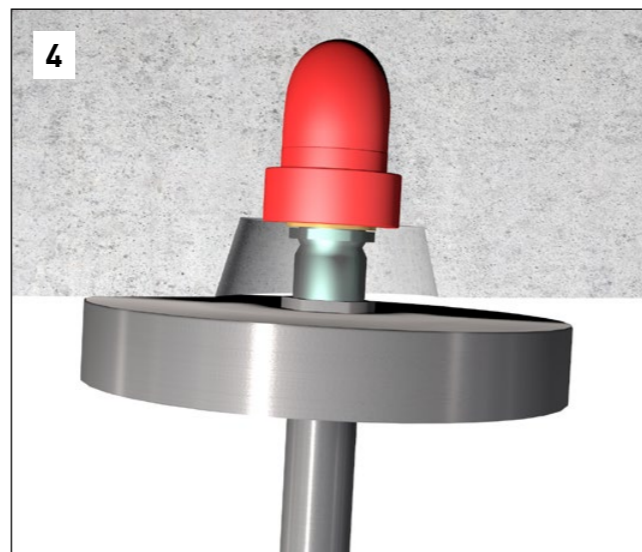
2) This requires a special adjusting tool. It is important to ensure that the bending radius is not more than 12°. The bearing surface of the female thread serves as a reference point on the surface.



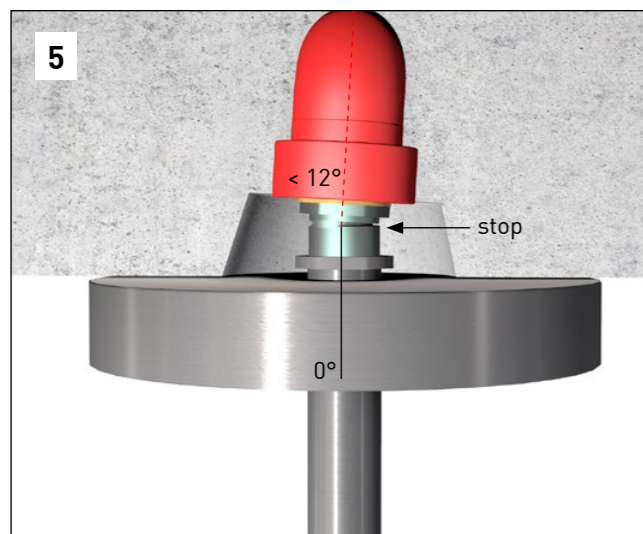
aquatherm red **compensating joint and adjusting tool** __



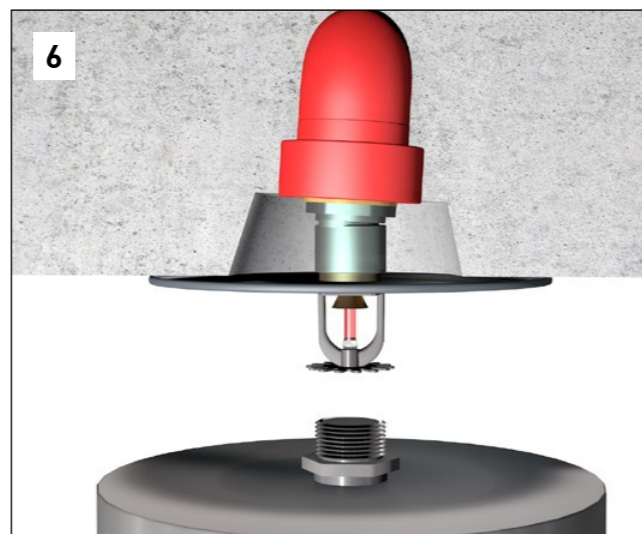
3) The adjusting tool is screwed into the balancing connection with the appropriate adapter.



4) With gentle pressure by hand, the compensating joint is pushed into its position until the plate of the adjusting tool fits proper against the concrete surface and locks into place. Bending back and forth is no longer possible.



5) The stop limits the bending radius to 12°.

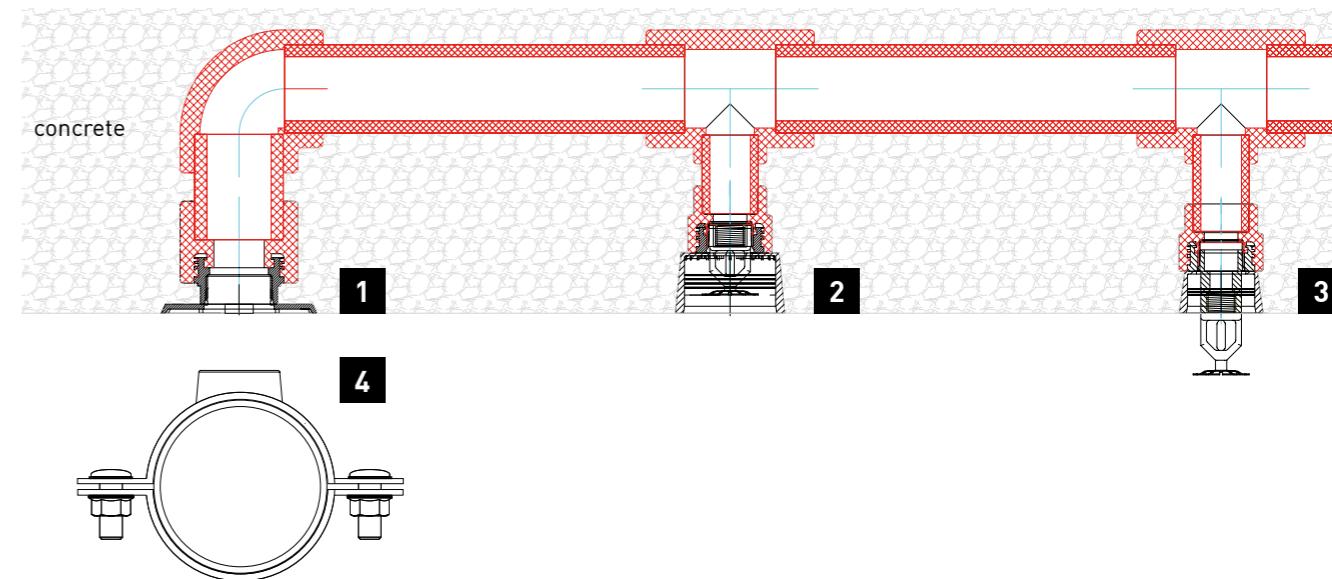


6) When the sprinkler is installed, the sprinkler connection is subject to the pressure test as usual and tested for leaks. The maximum operating pressure is 18 bar.

Adjusting tool for balancing connection page 70 Art. no. 9800050291

Compensating joint page 60 Art. no. 9604114231
 Art. no. 9604114233
 Art. no. 9604114235
 Art. no. 9604114237

Laying of aquatherm red **in the concrete** __



- 1** aquatherm red outlet 1 1/4", 1 1/2" and 2".
- 2** aquatherm red sprinkler outlet for covered sprinkler 1/2", 3/4" and 1".
- 3** aquatherm red sprinkler outlet for visible sprinkler 1/2", 3/4" and 1".
- 4** aquatherm red to steel pipe adapte

ATTENTION:
 All upper parts of sprinkler outlet must be pulled out of the concrete with the aquatherm red extraction tool (Art. no. 9800050290).

We recommend the aquatherm red combi extraction tool Art. no. 9800050290 for the sprinkler junction boxes Art. no 3090000002-3090000008.

For more information on the sprinkler junction boxes and junction boxes can be found in the tables from page 58.

Description of the installation in **prefabricated concrete ceiling (filigree ceiling)** __

Introduction:

Because precast concrete products are directly shuttered and processed at factory, there remain only some working steps at site. A slab formwork on site is not required. The rapid laying and on-site-installation saves time and costs. Due to the very smooth soffit by the steel formwork table, a plastering is not necessary.

If an installation system is mounted on the steel formwork, this must work precisely, safely and quickly.

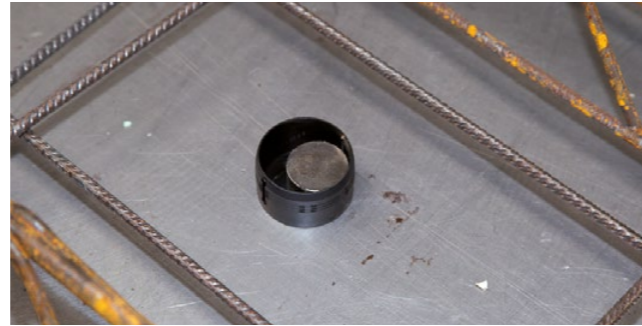
The sprinkler outlet of the sprinkler pipe system aquatherm red can be easily mounted on steel formwork. The entire component is assembled in advance by an installation company and delivered to the concrete plant.

In the concrete plant, the sprinkler outlets are measured on the steel formwork and mounted.

Assembly:

The base part of the sprinkler outlet is fixed with a magnet (min. holding force 23 kg), or with a hot-melt adhesive (temperature 100 °C) to the steel formwork with reinforcement and also keeps the position during vibrations.

The length of the pipe connecting piece has to be dimensioned so that it is protected by the projecting reinforcement on the transport to the site. The pipe connecting piece is protected by a protective cap and adhesive tape, thereby preventing the penetration of concrete into the interior of the pipe during filling of the mold.



Base part of sprinkler outlet Art. no. 3090000001 for visible sprinklers. Attachment by magnet.



Base part of sprinkler outlet art. no. 3090000005 for concealed sprinklers. Attachment with hot-melt adhesive.



The upper part of the sprinkler outlet with pipe connection is attached to the base part of the sprinkler outlet.



1. Type of connection: visible sprinkler

2. Type of connection: concealed sprinkler

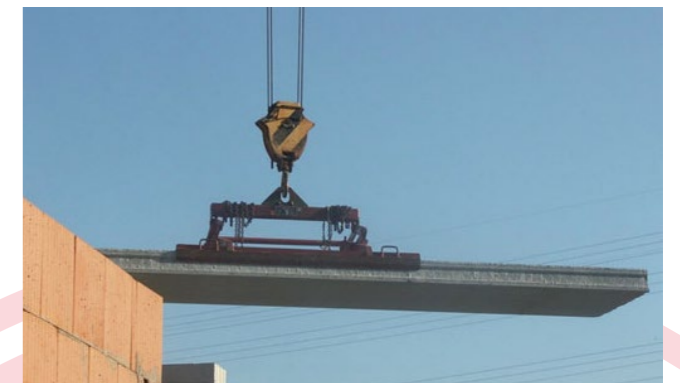
Description of the installation in **prefabricated concrete ceiling (filigree ceiling)** __

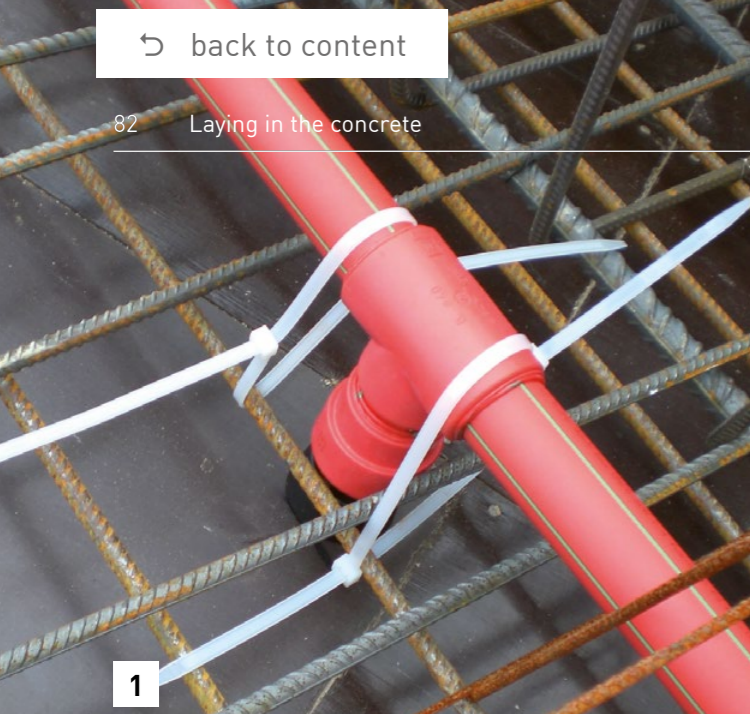
Assembly:

The mold is filled with concrete and vibrated simultaneously. After shaking the concrete surface is roughened. The component is to dry in a drying chamber.

After drying, the ceiling component is transported to the site and assembled. An installation company can now connect the sprinkler connections with each other and connect them to the supply pipe.

Thus, this method of prefabrication allows shorter construction periods and larger areas. This results in a cost reduction on the one hand and some more flexibility – all in all an increase of economy.





PART 2:

Pressure test of pipe work installation as strength test and leak test:

Please refer to the information on the following pages.

PART 3:

What must be considered during the concreting process?

All sprinkler connections have to be locked with cable clips (picture 1) and to underpin (picture 2).

Pipes and sprinkler connections must be fitted with suitable material (see fig. 1) in order to avoid bending. The sprinkler connection (sprinkler outlet) must be in the correct position. If necessary, this should be aligned and refastened before concreting.

The pipe sections must be fixed every 1.5 to 2 m in a way (using pipe hangers or lacing cord) to avoid sagging or bowing during the concreting process. It is important, that the pipe work is completely embedded without any hollow spaces (cavities).

The entering of the pipes during the concreting process must be avoided.

The compacting of the concrete with concrete vibrators in the pipe area should be carried out carefully.

Impacts, especially at low temperatures (below +5 °C) must be avoided.

Open pipes and connections must be closed before the concreting.

Damaged pipe work in concrete, e.g. by drilling work

Damaged pipe work can be repaired by fusion welding (see aquatherm red sprinkler system, Part B).

The aquatherm red system can also be repaired using the pipe repair stick (see aquatherm red sprinkler system, Part F).

PART 4:

Bridging of expansion joints

The expansion of aquatherm red pipes depends on the temperature of the pipe material. Cold water supplies cause hardly any expansion for a normal assembly nor do normal outside temperatures. The expansion need not to be considered when laying aquatherm red in the concrete. Rising pressures- and tensile stresses are not critical, as they are absorbed by the material.

However, if it is necessary to bridge the expansion joints, the aquatherm red pipes must be equipped with an approx. 25 cm protection pipe at both ends of the joint.

A confirmation of the responsible architect resp. structural designer must certify that no lengthwise movements in the expansion joints can be expected.

Bridging of building joints is not permitted.

The coefficient of expansion of aquatherm red pipes is 0.035 mm/mK.

The coefficient of expansion of concrete is 0.05–0.12 mm/mK.

PART 5:

Potential equalizing

The VDE 0190 Part 410 and 540 requires a potential equalizing between all kinds of earth conductors and the existing "conductive" potable and waste water supplies and heating pipes. As aquatherm red is not a conductive pipe system, it cannot be used for potential equalizing and thus needs no earth wiring.

The potential equalizing is made according to VDE-standard from the building parts, which have to be earth wired, directly to the potential equalizing rail to the planned position. The constructor or site manager must advise the client or his representative, that an approved electrician must check, if the aquatherm red installation does not affect the existing electrical protection and earth wiring measurements (VOB Part C, generaltechnical conditions of contract ATV).

PART 6:

Pressurizing in the aquatherm red supply during the concreting process

During the concreting process the pipe must be pressurized with the admissible operating pressure, so that a damaged point is visible at once.

After the pressure test the admissible operating pressure is kept by shut off of the respective pipe. The applied measuring devices must grant a correct reading of pressure changes of 0.1 bar.

The pressure measuring device shall be installed at the deepest point of the pipe system.

PART 7:

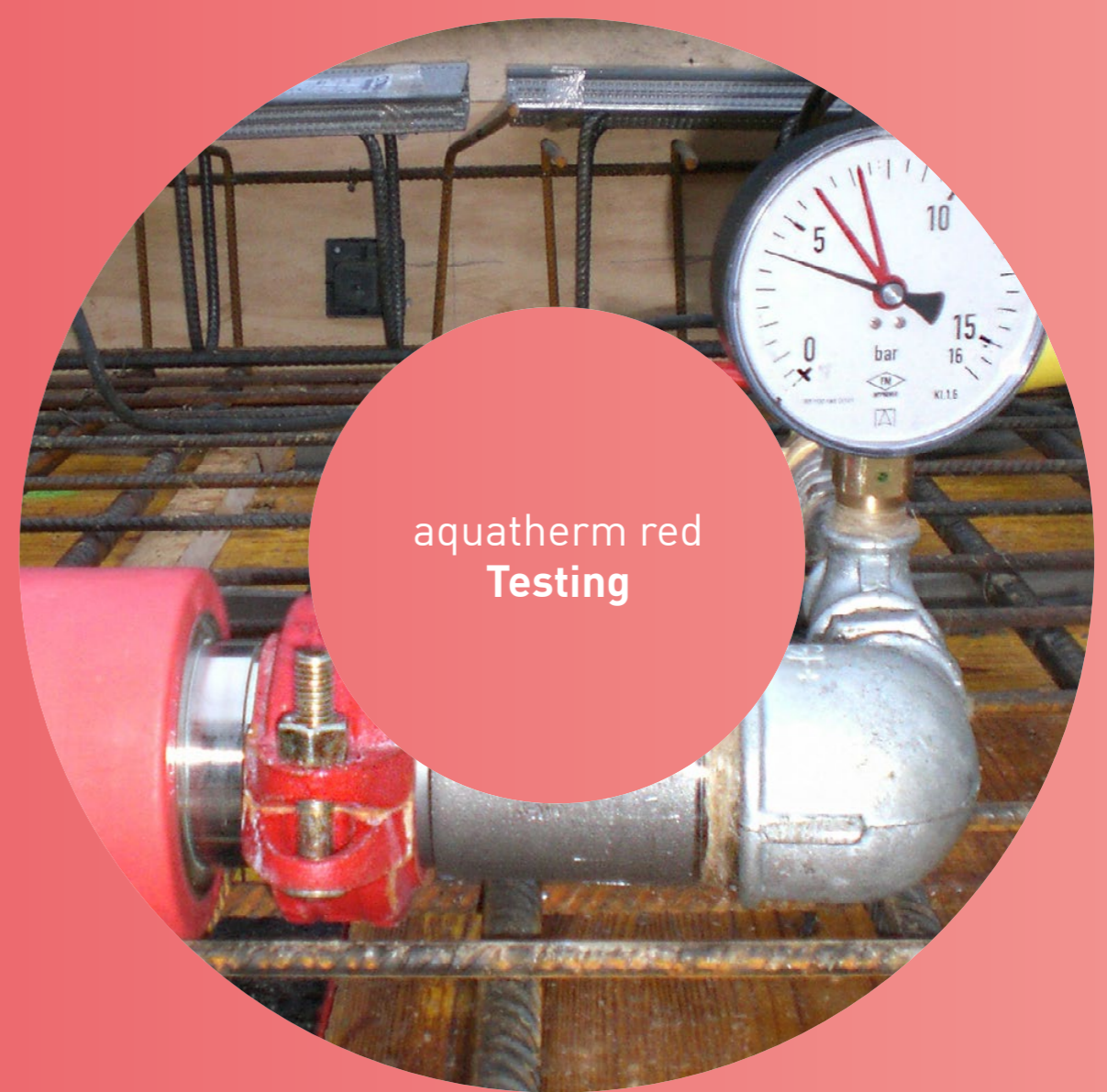
Influence of the concrete on the applied compounds

The aquatherm red pipe system contains all required compounds for a complete system installation. Mixed installation with non-system and/or non-material compounds are not required.

All material is resistant to corrosion. The threads of the aquatherm red sprinkler connection fittings are made from brass (CuZn36Pb2As).

Experiences with this material confirm that the alloy has an excellent resistance against concrete.

The general building regulations have to be complied with locally. If special chemical additives (retarder etc.) are applied, information from the manufacturer of the concrete should be gathered; refer to aquatherm for suitability.



aquatherm red
Testing

TESTING

Leakage test & chemical resistance

LEAKAGE TEST

All sprinkler pipelines shall be subjected to a hydraulic pressure test with a test-pressure of 10 bar.

Before the frost period begins, all aquatherm red lines must be drained to prevent frost damage. If there is a risk of freezing, suitable countermeasures must be taken, e.g. heating the building, using anti-freeze.

The material properties of the aquatherm red pipes result in an expansion of the pipes during the pressure test. This affects the test result. Due to the thermal expansion coefficients of the aquatherm red pipes the results are influenced additionally. The temperature differences between the pipe and the test medium lead to changes in pressure. Hereby a temperature change of 10 K corresponds to a pressure difference of 0.5 up to 1 bar.

Therefore, pressure testing of the aquatherm red pipe systems should be made with a constant temperature of the test medium. The hydraulic pressure test requires a preliminary, principal and final test.

In the preliminary test a pressure of 18 bar is applied 3 x 5 minutes for the expansion/release of the pipes. Between the cycles the pipe system must be depressurized.

Immediately after the preliminary test the principal test should be performed. The test duration is 15 min. Here, the test pressure (10 bar) may not fall more than 0.5 bar.

After completion of the preliminary and principle test finally the final test must be performed. The test duration is 60 minutes. Here, the test pressure – read after the principle test – may not fall more than 0.5 bar.

Measuring of the test pressures

Measuring has to be done with a manometer allowing a perfect reading of a pressure change of 0.1 bar. The manometer has to be placed at the deepest point of the installation.

Test record

A record of the hydraulic pressure test has to be prepared and signed by the client and contractor stating

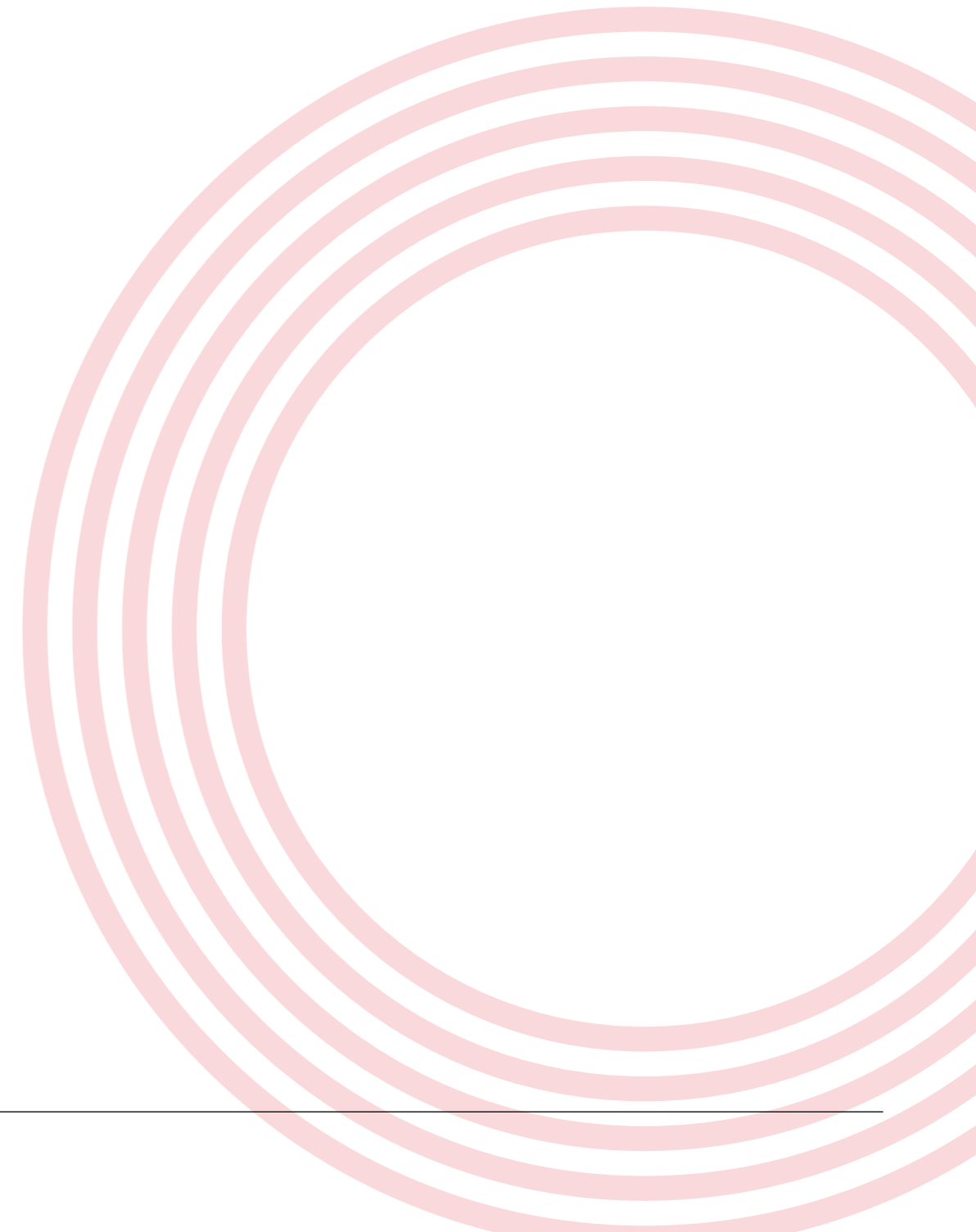
↶ Leakage test

CHEMICAL RESISTANCE ENQUIRY

aquatherm red pipes and fittings are characterised by special chemical resistance. aquatherm red connection elements with threaded inserts made of brass are not suitable for all media.

In industrial applications of aquatherm red pipes we recommend the use of aquatherm red flanges with weldable flange adapters and/or transition pieces for connection.

↶ Chemical resistance





aquatherm red
Fields of application

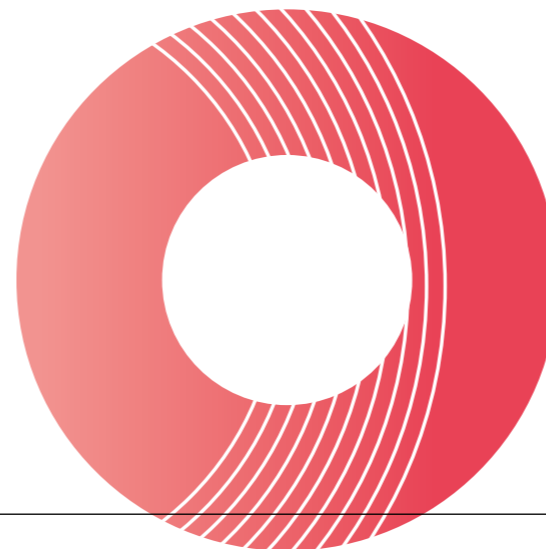
Fields of application

aquatherm has the solution for your challenge - Benefit from the versatile application possibilities of our products. The field of application of aquatherm products is wide. Here you get an overview of the fields of application in which you can rely on our products. Yesterday. Today. Tomorrow.



AQUATHERM RED FIELDS OF APPLICATION

Fire protection and sprinkler systems Invisible fire protection with AQUATHERM RED



Effective protection not only for industrial and commercial construction - To ensure effective fire protection, a sprinkler system is often essential, whether in industrial or commercial construction, hotels, stadiums or residential buildings.

aquatherm red is a plastic sprinkler pipe system with very special material properties: It is flame retardant (building material class B1) and offers maximum safety thanks to the welding of pipe and fitting.

Another advantage becomes apparent when the pipe is laid directly in concrete:
Due to its extremely corrosion-resistant material, aquatherm red is a particularly suitable option for this.

For comparison:
When using metal sprinkler systems, corrosion occurs as soon as the metal and the wet concrete meet. Corrosion can only be prevented with the aid of special protection, which makes the installation of metal pipe systems in concrete complex and expensive.

Compared to metallic pipes, aquatherm red also has a considerably lower weight. Of course, aquatherm red is VdS and IBS certified.



aquatherm red
Quality assurance

AQUATHERM QUALITY ASSURANCE

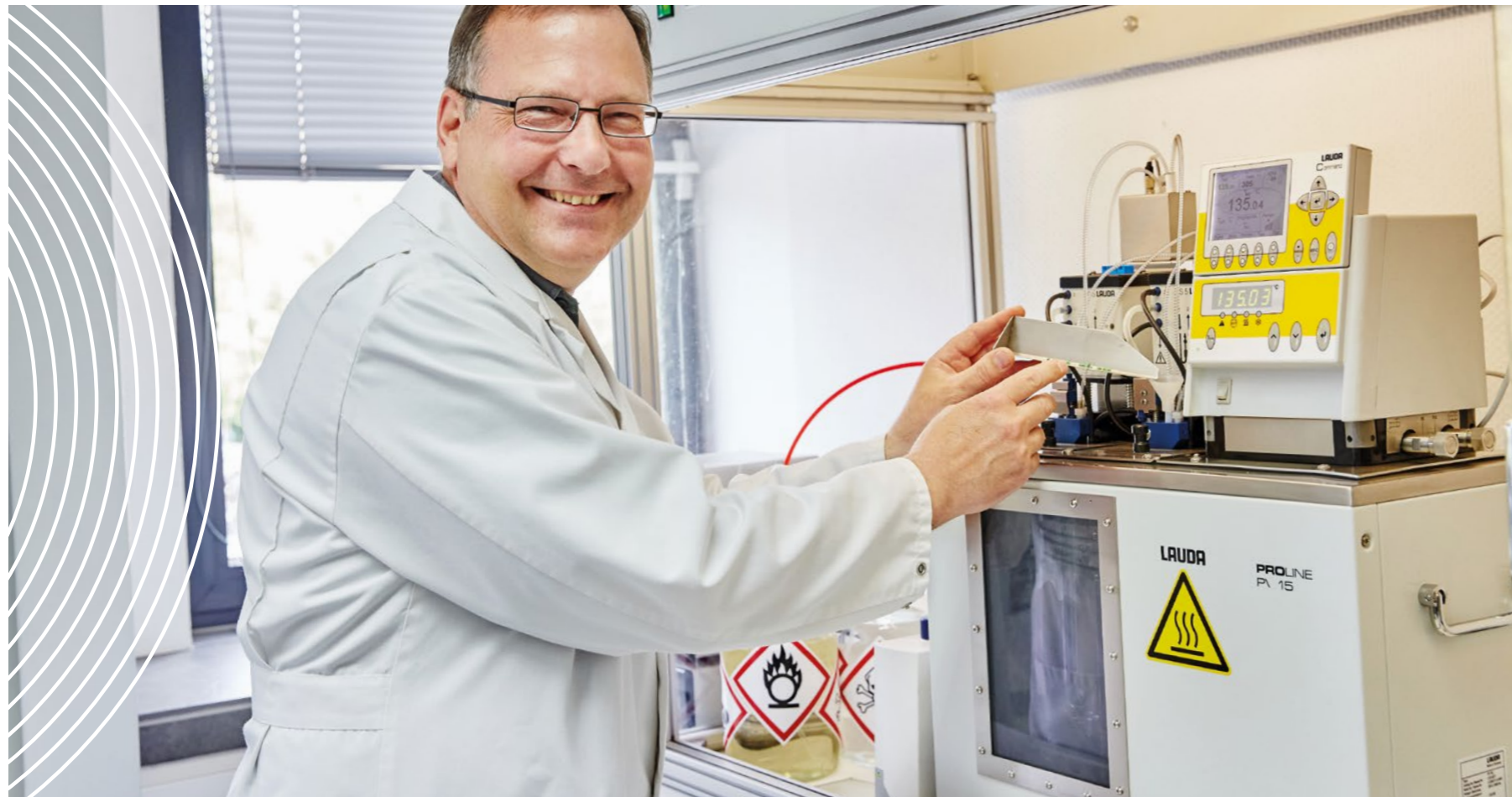
Quality „100 % Made in Germany“ __

To produce safe and innovative piping systems - that is the lived promise of aquatherm. This already starts with the raw material: We develop and refine our polypropylene granulate under the fusiole® brand. This way we can always perfectly adjust the properties of our products to the requirements of the different fields of application.

No matter whether its pipes or fittings: „100 % Made in Germany“ applies to all of them. We produce exclusively and with the latest manufacturing technology at our German sites in Attendorn (headquarters), and Ennest.

Only tested products then start their journey to our customers worldwide. In addition to the permanent in-house quality assurance, which includes the monitoring of testing equipment, process, production and incoming goods inspections as well as the final inspection, external monitoring is carried out by e.g. the Süddeutsche Kunststoffzentrum (SKZ), NSF (National Sanitation Foundation, USA), IIP (Istituto Italiano di Plastici, Italy), CSTB (Centre Scientifique et Techniquedu Bâtiment, France), TGM (Technologisches Gewerbemuseum, Austria) and the Hygieneinstitut des Ruhrgebiets. Numerous national and international neutral authorities and institutions confirm the high aquatherm quality standard.

Numerous national and international quality seals and approval certificates as well as our satisfied customers confirm again and again the high quality of our products. Since 1996 aquatherm fulfills the requirements of the quality management system according to DIN ISO 9001. This success is another step towards strengthening our competitive position and to meet the high requirements and the responsibility for our customers, partners and the environment See for yourself.



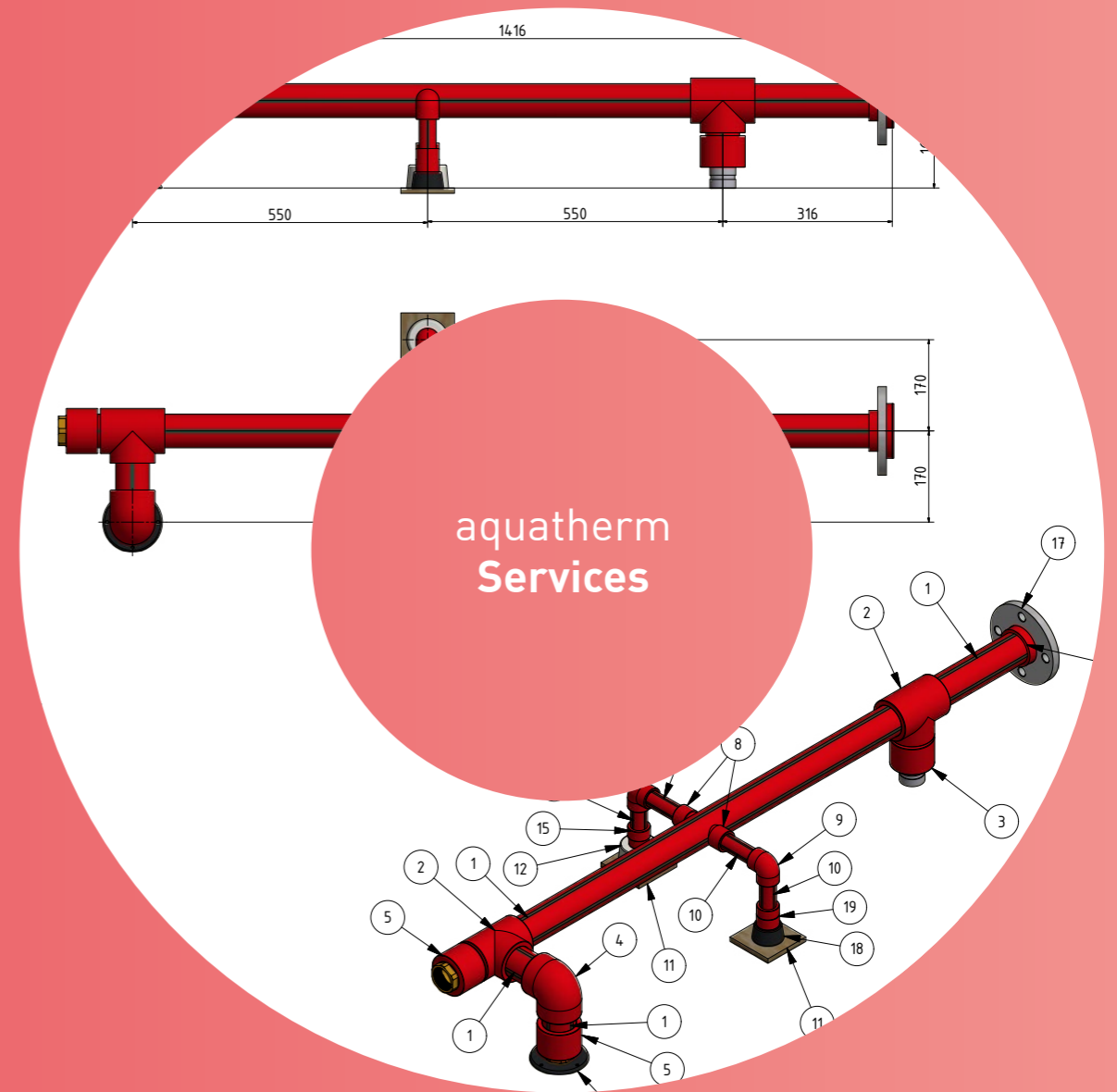
Compliance with the system standard __

Various national and international independent authorities and institutions confirm aquatherm's quality standard.

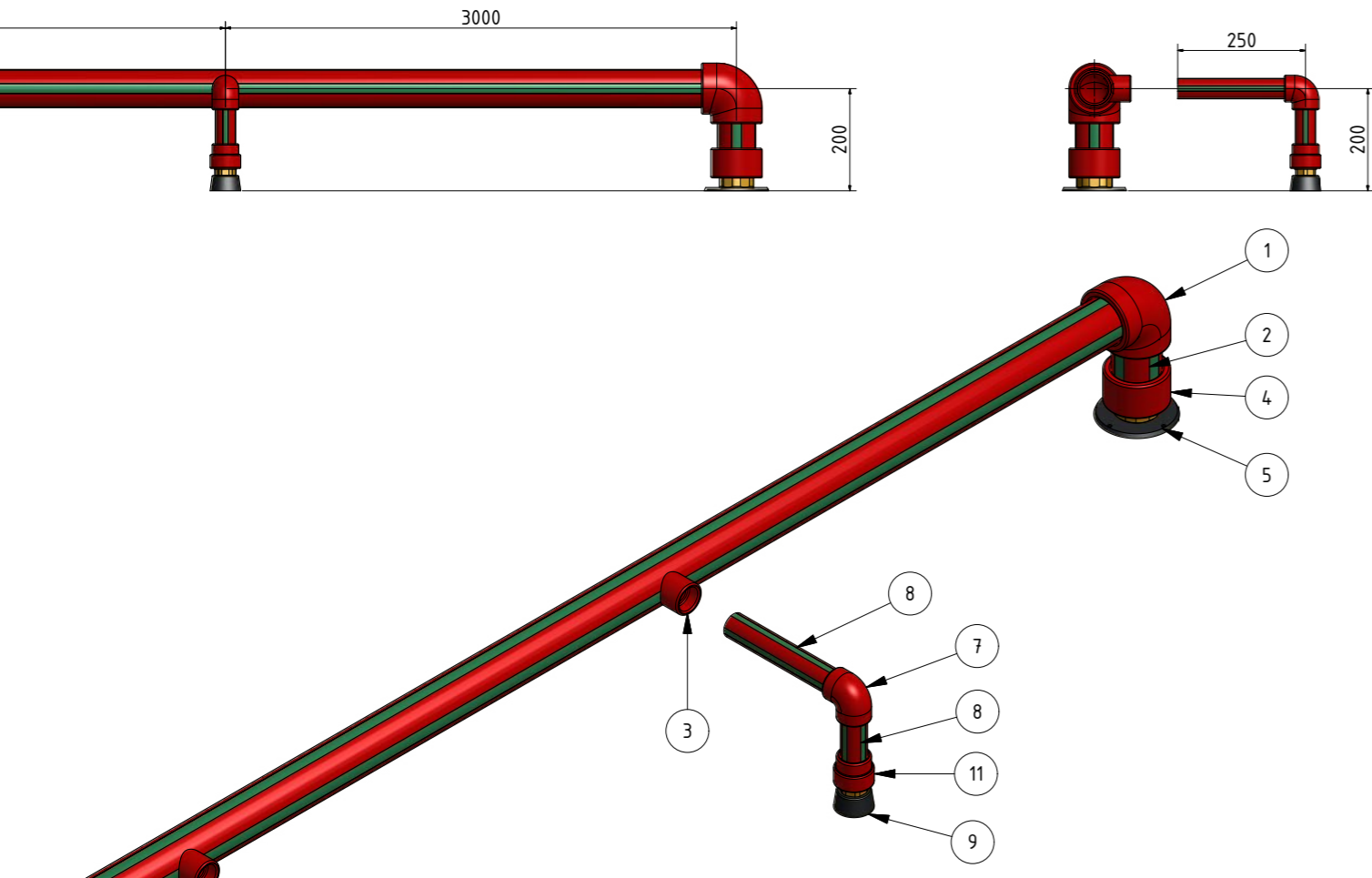
You can see our certificates on our website.

The product certificates are provided for reference purposes only. The certificates have been issued in accordance with the laws, regulations and product standards applicable in the respective country. The certificates can therefore not be used outside the respective jurisdiction. They contain neither express nor imply warranties of aquatherm GmbH or its affiliates.

You can find the overview of our international certificates here: [Certificates](#)



aquatherm
Services



AQUATHERM SERVICES

Example aquatherm prefabrication __

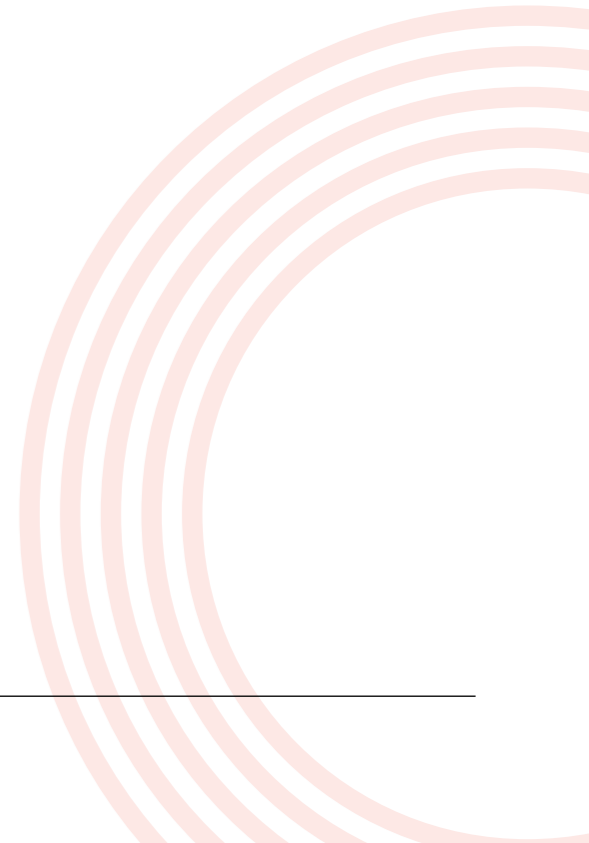
TEILELISTE

Objekt	Anzahl	Bauteilnummer	Beschreibung
1	1	4112120	Elbow 90° Ø
2	9.0 m	4170720	green 75 Ø SDR 9 MF RP
3	2	4115175	Weld in. Ø 75-40
4	1	4121122	Transition piece female Ø 75 2"
5	1	4114202	Sprinkler outlet 2"
6	1	4114208	Plug for sprinkler outlet 2"
7	2	4112114	Elbow 90° Ø 40
8	0.8 m	4170714	red Ø 40 SDR 7.4 MF HI
9	2	4114183	Upper part for sprinkler outlet G 1"
10	2	4118187	Plug for sprinkler outlet G 1"
11	2	4121115	Transition piece female Ø 40 1"

AQUATHERM SERVICES

Optimise the efficiency of your entire project workflow __

All of the pipework and supply lines required for projects from aquatherm red can be prefabricated at aquatherm can be prefabricated. This eliminates the need for numerous numerous welds on site, saving not only a lot of time but also labour is saved. The leak test is also carried out at the aquatherm factory so that the sprinkler pipes can then be delivered delivered to the construction site ready for installation.





aquatherm red
References

AQUATHERM RED REFERENCES

Fire protection and sprinkler systems

Project

Kö-Bogen I and II

Location

Düsseldorf, Germany

Completion

2021

Application

Sprinkler

The challenge

For Kö-Bogen I and the food court of Kö-Bogen II, a sprinkler piping system was sought that was not only safe and made of sustainable material, but that could also be laid directly into the concrete of the floor slabs.

The solution

aquatherm red fulfilled these requirements and ensured among other things that the representative entrance area of the food court received a discreet sprinkler solution in a visually beautiful exposed concrete ceiling.





AQUATHERM RED REFERENCES

Fire protections and sprinkler systems

Project
KTM Motohall

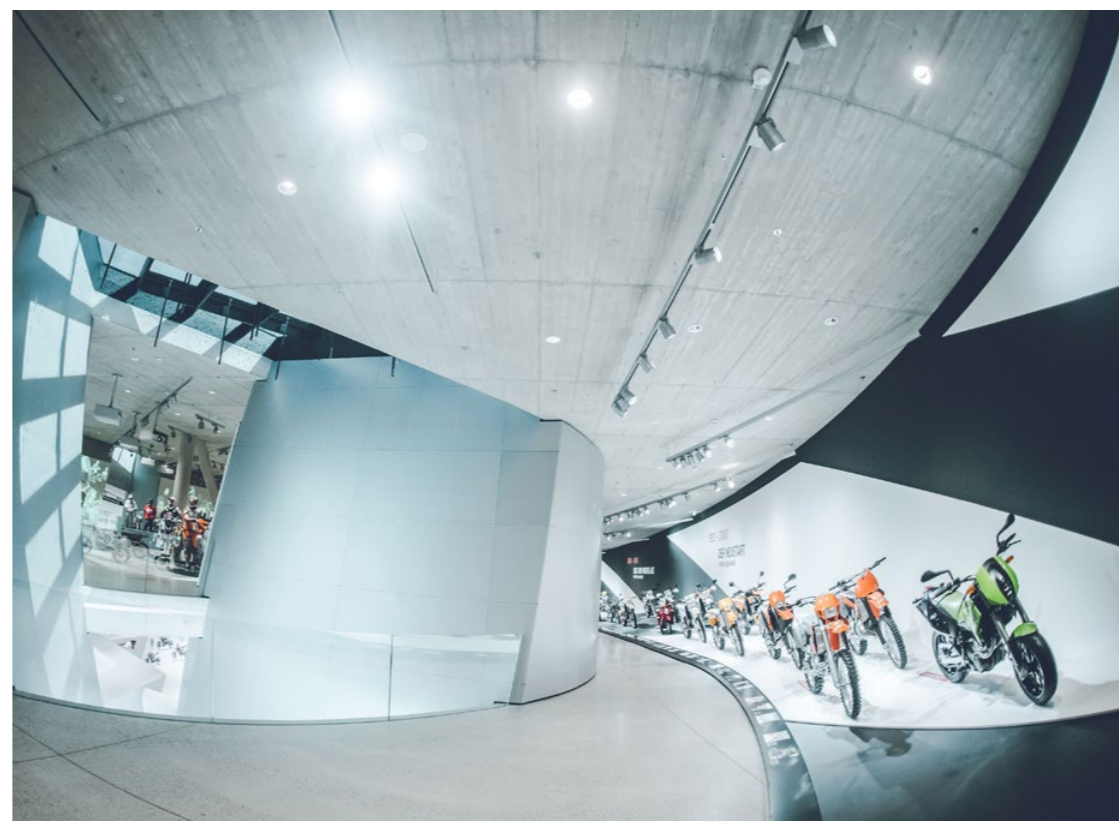
Location
Mattighofen, Austria

Completion
2019

Application
Sprinkler

The challenge
The sprinkler system of the KTM Motohall was to blend almost invisibly into the architecture.

The solution
aquatherm red was laid directly in the exposed concrete and thus offers an invisible fire protection for the visitors of the racing exhibition.



AQUATHERM RED REFERENCES

Fire protection and sprinkler systems

Project

UN Campus

Location

Bonn, Germany

Completion

2021

Application

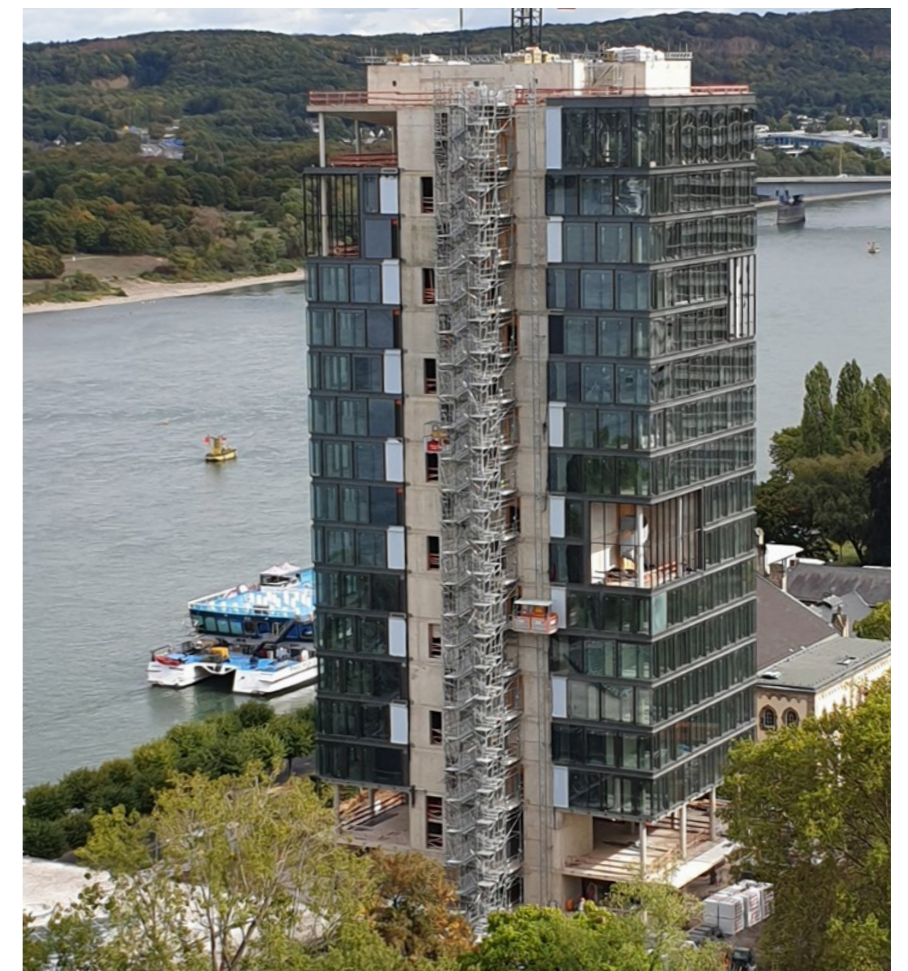
Sprinkler

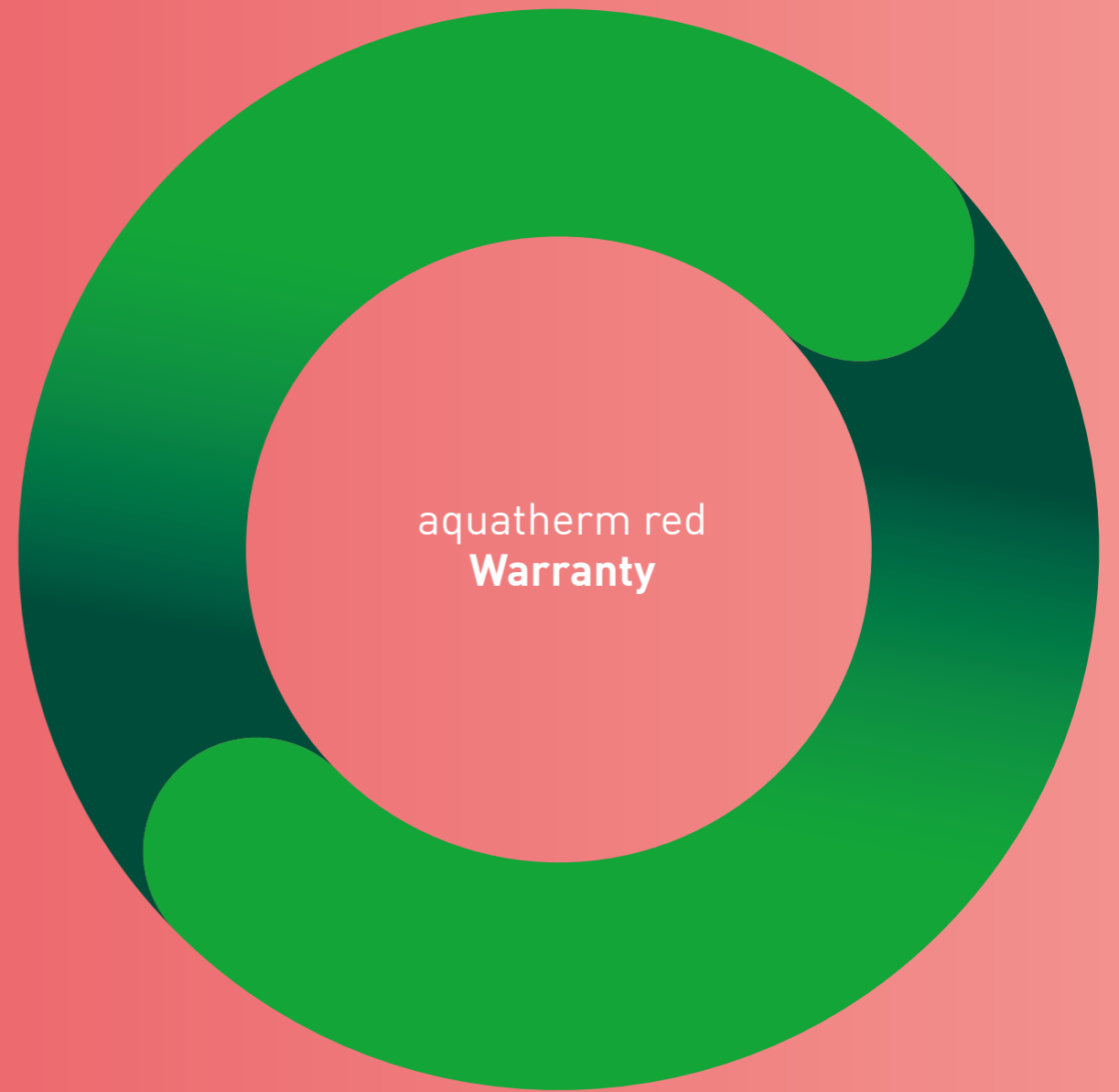
The challenge

For the new building on the UN Campus, a sprinkler system was sought that could be laid directly into the concrete of the floor slabs in a hollow core ceiling.

The solution

Despite the air chambers used in this type of ceiling, aquatherm red could be easily integrated into the floor slabs due to its flexibility. In addition, the system ensured an improved construction process thanks to prefabricated elements. In addition, the system ensured an improved construction process thanks to prefabricated elements.







Explanatory comments on the aquatherm GmbH warranty __

1. Foreword

Thank you very much for making the decision to use a product from aquatherm GmbH, Germany (herein referred to as "aquatherm"). With nearly 50 years of experience in the international plastic pipes market, and our trendsetting innovations, we have the expertise needed to offer you engineered piping solutions made in Germany.

The trust placed in the quality of our products has motivated us to offer all pipes and moulded, fabricated, machined, and/or assembled parts with a 10-year warranty instead of the standard 2-year warranty required by German law. This extended time covered by warranty is backed by a comprehensive insurance policy from a leading insurance company for our line of business. The warranty period will begin with the date of delivery by aquatherm GmbH, but only comes valid with the successful pressure test, which must be carried out and documented in accordance with the aquatherm specification.

2. Scope of warranty

The aquatherm warranty protects you from financial loss proven to be caused by material defects, manufacturing defects and/or aquatherm's consulting/engineering services. The warranty coverage shall apply for the following product groups:

- aquatherm green pipe (fusiotherm und aquatherm ISO)
- aquatherm blue pipe (climatherm und aquatherm ISO)
- aquatherm red pipe (firestop)
- aquatherm black system (climasystem)
- aquatherm lilac pipe (aquatherm lilac)
- aquatherm orange system (aquatherm heating systems)
- aquatherm grey pipe (aquatherm SHT-system)
- assemblies fabricated by aquatherm from these product groups

2.1 What is covered by the aquatherm warranty?

The aquatherm warranty covers three aspects of damages: property damage, financial loss and personal injury.

2.1.1 What is property damage?

The damage to or destruction of a tangible item as a result of a defective product (e.g. classic water damages as a result of a leak). As a result of this, the suitability of the tangible item to fulfill its actual purpose is impaired. The term property damage is used if tangible items are damaged or destroyed. Considerable costs can be incurred as a result of property damage, such as renovation costs, repair costs or replacement costs.

2.1.2 What is meant by financial loss?

Financial loss may either be out-of-pocket loss or loss of business. Out-of-pocket financial loss is for example the costs of removing products and installing replacements after damage. Loss of business is the financial disadvantage suffered by an injured party as a result of a dama-

ging event (e.g. lost income as a result of renovations following property damage).

2.1.3 What is meant by personal injury?

If a person suffers physical injury, this is known as personal injury. For the purposes of this document, the coverage of personal injury means the direct medical costs incurred as a result of the injury.

3. What is not covered?

Costs related to the damages incurred such as a result of:

- Non-compliance with the operating parameters defined and specified by aquatherm as found in aquatherm's technical documents. In cases of doubt, contact your local aquatherm manufacturer's rep. Exceptions must be provided for, in writing, by a member of aquatherm's engineering team.
- Non-compliance with the installation guidelines as set out in the aquatherm Catalogue, with emphasis to the required installation of aquatherm propriety clipping or other compatible with aquatherm piping.
- Non-compliance with respective National Plumbing Standards and Regulations.
- Joints which were not made in accordance with the aquatherm guidelines, including but not limited to: improper fusion technique, use of contaminated materials or tools, use of faulty or unsuitable tools, use of damaged materials or tools, or any connection made by an installer without sound knowledge of the aquatherm connection techniques and their processes.
- Improperly assembled connections to other pipeline systems and/or components (threads, flanges, stubs, mechanical joints not intended for use with aquatherm PP piping etc.).
- All sealing elements used in the product lines manufactured by aquatherm.
- Tools and accessories sold by aquatherm GmbH are covered for the warranty period by law under the statutory warranty provisions.
- Systems with defective pipeline sections or fittings that were not subjected to the aquatherm pressure test or alternative testing approved by aquatherm prior to start-up.
- Damage to our products caused by incorrect handling after the material has left aquatherm's possession.
- Damage caused or exacerbated by copper in the water resulting from erosion/corrosion or other degradation of copper components in a domestic hot water recirculating system.
- Time delay, caused by incorrect planning, delivery problems and/or incorrect orders.
- Damage caused by entrained air, cavitation and pressure fluctuations.

Note: This list only includes the most prominent examples. Other circumstances, which compromise the integrity of the products, may also jeopardise the coverage.

4. How is the amount of compensation under the aquatherm warranty determined?

In the event of a material failure, samples of the damaged/faulty product are collected by the national aquatherm partner to forward them to aquatherm GmbH for examination and analysis. Working in collaboration with the injured party, aquatherm will identify the cause of the damage, and call in external bodies (test institutes, laboratories, assessors, etc.) as needed. If the damage has been caused by a material and/or manufacturing defect or by aquatherm's consulting/engineering services, the underwriter shall quantify the compensation claim for damages. All expenditures associated with the damages for this claim must be verified/recorded in detail and in a verifiable format as a required measure.

5. How much is the maximum coverage?

For the first 5 years of the warranty period, property damage, personal injury and financial loss is covered for the sum of €20 million per insurance claim. Total coverage for all claims made in a year is a maximum of €40 million. For years 6-10 of the warranty period, these coverage amounts are €8.5 and €17 million respectively. Sublimit for losses on designed projects (Professional Indemnity) €2 million and €6 million for all losses in the annual aggregate.

6. Why is the coverage stated in Euro?

The insured manufacturer, aquatherm, as well as the insurer, are both based in the EU, so that their agreements are issued in Euros (€). Since exchange rates fluctuate, the exchange rate current on the date of compensation shall apply.

7. What is the channel of communication for notifying claims under warranty and making enquiries about them?

Warranty claims have to be made to aquatherm via the national aquatherm GmbH partners. Information about the progress of the claim will only be released by the aquatherm partner or aquatherm GmbH.

8. Legal note

If a discrepancy or conflict arises between this document and the underlying insurance policy, the latter shall in all cases prevail.

9. Information about avoiding damage

I) Manufacture under certified quality level

As a trusted manufacturer, aquatherm works to a certified quality standard (ISO 9001); constant internal quality controls are part of the daily routine. In addition to this, all employees are integrated into a quality assurance program. As a result of this, products failing to comply

with our high standards are quickly identified and removed from our product range.

II) **Preventing damage caused by incorrect handling**
Our products must be handled conscientiously and carefully when they are delivered from our production plants. Experience shows that most damage is caused in transit, storage and/or when working on site. At this point we would draw close attention to the fact that correct handling contributes to maintaining the product quality.

III) **Work is to be carried out by qualified installers**
Installation defects are easy to avoid. Our training courses teach the correct techniques in detail for working with our products. In doing so, particular importance is attached to work being carried out attentively and with care. The work of installers trained by us or our aquatherm partners is much more reliable and carried out much more efficiently.

For a safe connection, we recommend using only aquatherm PP products in a piping system. Mixing with other PP piping systems should be avoided.

February 2023
aquatherm GmbH, Biggen 5, 57439 Attendorn, Germany



aquatherm red
Transport and storage

AQUATHERM TRANSPORT AND STORAGE

Careful storage __

aquatherm polypropylene pipes may be stored outside at any temperature. A solid base for the pipe is very important to avoid a deformation of the pipes while in transport and storage.

At temperatures below 0 °C it is possible to damage the pipes through strong impacts. The material has to be treated with caution at low temperatures. In spite of its high resistance, aquatherm pipes should be

treated with care. UV-radiation has effects on all high polymer plastics. Do not store permanently outdoor.

The maximum permissible storage time outdoors is 6 months.





aquatherm GmbH

Biggen 5 | 57439 Attendorn | Deutschland
Tel: +49 2722 950 0 | Mail: info@aquatherm.de

Status: 01.2024



Management System
ISO 9001:2015
ISO 14001:2015
ISO 50001:2018
www.tuv.com
ID: 0091005348

Part of the Solution
www.aquatherm.de